

AKUWA325COM11 TO DB JAN79  
KUON RADIO  
D S 50 UNIV OF WASH  
325 COMMUNICATIONS BLDG  
SEATTLE WA 98105

**IN THIS ISSUE:**

- The Why and How Of Equalization
- The New Breed of VU Meters
- Test Report: UREI Response Plotter

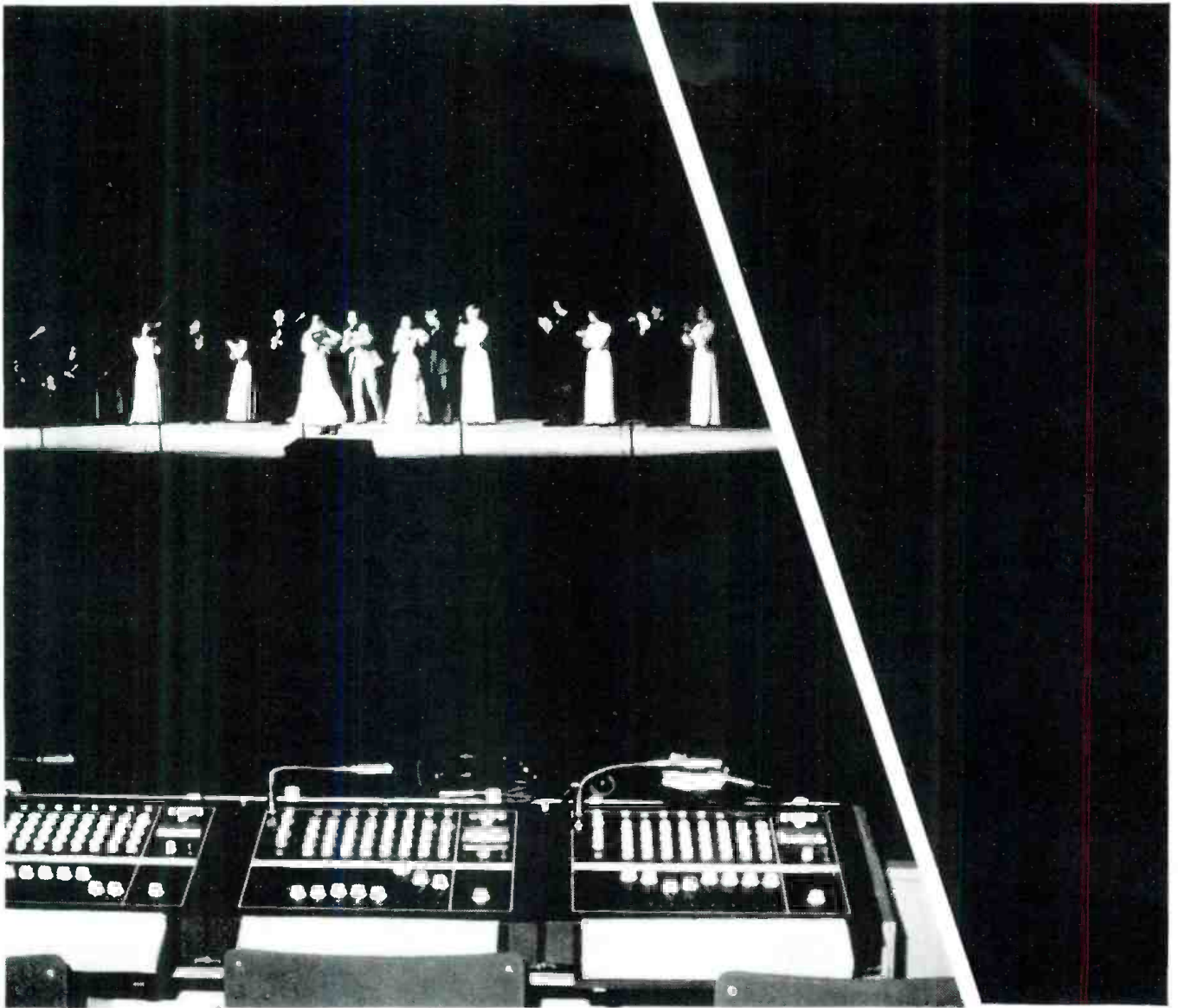

## Standing Room Only for SR



Shure's SR auditorium-size professional sound reinforcement componentry is probably the only equipment that's been field-proved in Opryland, Las Vegas and Moscow. The SR's modular flexibility has proved its adaptability in outdoor rockfests, theaters, amusement parks, and on the road with many of the world's popular entertainers. Best of all, the SR's rugged durability and enormous power potential make it the expandable sound investment of a lifetime. SR components can be used as a *system*, or inserted as *individual links within a system of quality componentry in virtually unlimited combinations*. For our "SR Sound Ideas" application guide, as well as the complete new SR catalog, write:

Shure Brothers Inc.  
222 Hartrey Ave., Evanston, IL 60204  
In Canada: A. C. Simmonds & Sons Limited



Manufacturers of high fidelity components, microphones, sound systems and related circuitry.

Circle 10 on Reader Service Card

[www.americanradiohistory.com](http://www.americanradiohistory.com)

## coming next month

● The growing field of studio automation control will be spotlighted in November.

● British author John Borwick details the Neve NECAM system, while our own John Woram reports on two visits, one to Nashville, where he spoke with Allison's Paul Buff and the other to the closer shores of Huntington, N.Y., where API's Lou Lindauer detailed their latest system.

● Automation of a different kind is explained as a result of another trip, this one made by editor Larry Zide. His visit to Ampex resulted in an interview with the key developing engineers of the new ATR-100 series that details the logic (pun intended) which created this system.



THE SOUND ENGINEERING MAGAZINE

OCTOBER 1976, VOLUME 10, NUMBER 10

39	THE WHY AND HOW OF EQUALIZATION Arthur R. Johnson and Robert M. Hess
44	THE NEW BREED OF VU METERS Ronald Ajemian
46	TEST REPORT: UREI RESPONSE PLOTTER
2	INDEX TO ADVERTISERS
2	LETTERS
8	CALENDAR
10	THEORY & PRACTICE Norman H. Crowhurst
16	THE SYNC TRACK John M. Woram
24	BROADCAST SOUND Patrick S. Finnegan
30	SOUND WITH IMAGES Martin Dickstein
33	NEW PRODUCTS AND SERVICES
49	CLASSIFIED
52	PEOPLE, PLACES, HAPPENINGS

db is listed in Current Contents: Engineering and Technology

**Robert Bach** PUBLISHER  
**Larry Zide** EDITOR

**Bob Laurie** ART DIRECTOR  
**John Woram** ASSOCIATE EDITOR

**Eloise Beach** CIRCULATION MANAGER  
**Hazel Krantz** COPY EDITOR

**Lydia Anderson** ASST. CIRCULATION MANAGER  
**Ann Russell** PRODUCTION

GRAPHICS **Crescent Art Service**

db, the Sound Engineering Magazine is published monthly by Sagamore Publishing Company, Inc. Entire contents copyright © 1976 by Sagamore Publishing Co., Inc., 1120 Old Country Road, Plainview, L.I., N.Y. 11803. Telephone (516) 433 6530. db is published for those individuals and firms in professional audio-recording, broadcast, audio-visual, sound reinforcement, consultants, video recording, film sound, etc. Application should be made on the subscription form in the rear of each issue. Subscriptions are \$7.00 per year (\$14.00 per year outside U. S. Possessions, Canada, and Mexico) in U. S. funds. Single copies are \$1.00 each. Controlled Circulation postage paid at Harrisburg, Pa. 17105. Editorial, Publishing, and Sales Offices: 1120 Old Country Road, Plainview, New York 11803. Postmaster: Form 3579 should be sent to above address.

## about the cover

● A lovely soft-focus shot of a performing rock group. We can't help wondering about that haze—just what was the photographer smoking?

THE WORD FOR TODAY  
IS  
**"NATURAL"**

[More or Less]

For years, all reverbs were just that - simply reverbs - until development of the MASTER-ROOM.

MASTER-ROOM claimed Natural Sound and demonstrated what is meant by that with its unique, full ambience properties of:

- Natural delay prior to first echo
- Natural group of first order echoes
- Natural build-up in amplitude
- Natural pattern random diffusion
- Natural build-up in echo density
- Natural proportioned decay
- Natural flat frequency response
- Natural smoothness without limiting

As a result of MASTER-ROOM, "NATURAL" is now the key word in reverberation equipment, but a word that is too often used without regard to its true meaning.

So thanks to all who have helped to make "NATURAL" the word in reverberation devices.

From the originator... the one who backs it up with performance.

**MICMIX AUDIO PRODUCTS, INC.**

9990 MONROE DRIVE, SUITE 222  
DALLAS, TEXAS 75220

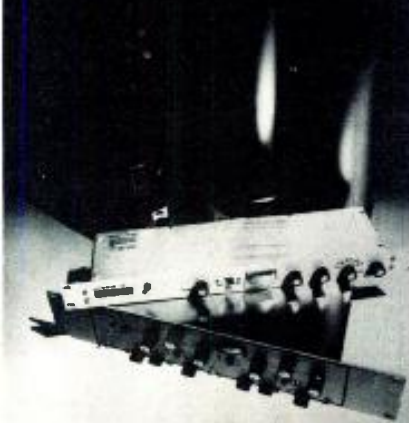

**dbb letters**

THE EDITOR:

On the basis of Don Davis' attack, I'm afraid I will have to take the side of the "overeager biamp proponent." To begin with, Mr. Davis' remarks about "audio's contribution to the power shortage" only show that he does not understand what it is that the targets of his sarcasm are trying to say. It just happens that "more watts for less power," or its equivalent, is a goal that good engineers in many fields strive for. Only, they prefer to call it "efficiency"!

I have not personally seen any claims of something for nothing. Rather, the claim appears to be that amplifiers in the biamp setup can work closer to their rated power before clipping sets in. (An amplifier can tolerate only so much voltage swing. And, Mr. Davis, given certain waveforms, the maximum can be reached while the actual power developed is almost nil. Under such a circumstance, bringing the waveform closer to the ideal can result in enormously more watt output from an amplifier with a given power rating. This is scarcely something for nothing.)

From this initial misrepresentation, Mr. Davis goes on to assert that one can just as well postulate a single signal as a dual one. True, but irrelevant. Where actual program material approaches the single sine wave ideal (flute solo?) there are few problems with system capacity or distortion. The real problems arise in the intermodulation situation.

Finally, he brings up his big guns and tries to draw a distinction between two "coherent" signals and two "incoherent" signals as regards the way they add together. His graphics are excellent, but his math goes slightly astray, due to the fact that he confuses effective voltage values with instantaneous. The upshot is that he would have us repeal Kirchoff's Second Law.

I think the law will survive. Note that it calls for instantaneous voltages to add together algebraically, not according to a root-of-the-sum-of-the-squares law. Further, there is nowhere another law which would prevent peaks in two differing signals from coinciding in time and polarity. In the non-sinusoidal case such coincidences could be expected to be less frequent but more intense than in the sinusoidal case; thus the clipping would be worse. This is the exact op-

**index of advertisers**

Allied Broadcasting Equipment	37
Ampex	17
Ashly Audio	42
BGW Systems	24
BPI	18
Cetec Audio	11, 43
Clear-Com	6
Crown International	41
dbx	4
Dynaco	9
Electro-Voice	25
Garner Industries	8
Gotham Audio	33
Inovonics	26
International Audio	18
JBL	19
Lexicon	38
The London Company	43
Magnefax, Inc.	16
Micmix Audio	2
Neumann	33
R. A. Neilson	8
Orban Parasound	29
Otari	29
Panasonic	3
Pulse Dynamics	24
Quad-Eight Electronics	5
Quantum Audio	22
Ramko Research	10, 14
Recording Supply Company	12
SAE	13
Sescom	28
Shure Bros.	Cover 2
Soundcraft Electronics	23
Sound Workshop	6
Stanton Magnetics	27
Willi Studer	21
Tara Audio	26
Tektronix, Inc.	7
Telex Communications	32, 34, 36
UREI	35
Unisync	22
Waters Manufacturing, Inc.	28
White Instruments	20
Yamaha	Cover 4

**dbb sales offices**

**THE SOUND ENGINEERING MAGAZINE**

**New York**  
1120 Old Country Rd.  
Plainview, N.Y. 11803 516-433-6530

**Roy McDonald Associates, Inc.**  
**Dallas**  
Stemmons Tower West, Suite 714  
Dallas, Texas 75207 214-637-2444

**Denver**  
3540 South Poplar St.  
Denver, Colo. 80237 303-758-3325

**Houston**  
3130 Southwest Freeway  
Houston, Tex. 77006 713-529-6711

**Los Angeles**  
500 S. Virgil, Suite 360  
Los Angeles, Cal. 90020 213-381-6106

**Portland**  
2035 S. W. 58th Ave.  
Portland, Ore. 97221 503-292-8521

**San Francisco**  
Suite 265, 5801 Christie Ave.  
Emeryville, Cal. 94608 415-653-2122

# Technics introduces components designed for professional use only.

The SE-9600P. Regulated stereo power amplifier with a lot more than just power. Like 100% constant-current and voltage power-supply regulation. Which means complete freedom from transient IM distortion. It also means high-level transients introduced in one channel won't affect the other. There's also only 0.08% IM distortion. A frequency response of 5 Hz to 150kHz (+0dB -3dB).

A S/N ratio of 110 dB. A 4-step damping factor control. And 110 watts per channel, minimum RMS, into 8 ohms from 20 Hz to 20 kHz with no more than 0.08% total harmonic distortion.

The SU-9600P. The stereo preamplifier that performs as well as it looks. Starting with an unheard of magnetic phono overload tolerance of more than 1 1/3 volts (1350mV RMS at 3mV sensitivity). An equally impressive phono-2 S/N ratio of 76 dB (referred to 3mV input). Virtually non-existent total harmonic distortion (0.02%). As well as bass and treble negative-feedback tone controls calibrated in 2.5 dB steps. With turnover pushbuttons at 125 Hz and 500 Hz as well as at 2kHz and 8kHz.

The SH-9090P. The Universal Frequency Equalizer that has no equal. You get 12 dB of boost or attenuation for 12 bands (10 Hz to 32 kHz). Plus the center frequency of each band can be continuously shifted by as much as  $\pm 1$  octave. In addition, the bandwidth (Q) for each of the 12 bands is continuously variable from 0.7 to 7. The result: You have more control over response shaping than with any other single instrument. (Configuration: one in, one out.)

The SP-10MKII. In every respect, it's everything you want in a professional turntable. So much torque it only takes 0.25 of a second to reach the exact playing speed at 33 1/3 RPM. Our lowest wow and flutter (0.025% WRMS) and rumble (-70 dB DIN B). A quartz-locked frequency generator DC servo motor. And, of course, the reliability of Technics direct drive. The system that radio stations use. And discos abuse. Supplied without tone arm.

Panasonic Company  
Technics Dept. 310  
One Panasonic Way  
Secaucus, N.J. 07094

Attention: Sid Silver,  
Technical Service Specialist.

- Send me technical information on the Technics Professional Series.  
 Have a Technics audio specialist call for an appointment.

NAME \_\_\_\_\_ TITLE \_\_\_\_\_  
Please Print  
COMPANY \_\_\_\_\_  
ADDRESS \_\_\_\_\_  
CITY \_\_\_\_\_ STATE \_\_\_\_\_ ZIP \_\_\_\_\_  
AREA CODE \_\_\_\_\_ PHONE NUMBER \_\_\_\_\_

**Technics**  
by Panasonic  
Professional Series

Circle 14 on Reader Service Card

# dbx your Dolby "A" and eliminate ALL the hiss



# with the new dbx K9-22 card noise reduction system

It's a direct plug-in replacement for the Dolby "A" CAT-22 card. It interchanges instantly with no adjustments. It gives you the flexibility to use both dbx and Dolby "A" formats with your existing Dolby main frame. It provides more than 30dB noise reduction and 10dB extra headroom. It eliminates the hiss which remains with Dolby "A". It gives greater than 100dB dynamic range. It requires no level match tones. It's affordable. It costs only \$250 per channel, or less than half the cost of a free standing noise reduction system. It can go wherever you go in its optional Halliburton travel case. It's the new world standard in noise reduction. It's available now from your dbx dealer whose name we'll supply along with complete product information when you circle reader service number or contact:

Dolby is a trade mark of Dolby Laboratories.

# dbx

dbx, Incorporated  
296 Newton Street  
Waltham, Massachusetts 02154  
(617) 899-8090

Circle 32 on Reader Service Card

posite of what Mr. Davis has "proved." to at least his own satisfaction.

WARNER CLEMENTS  
Sherman Oaks, CA

*Mr. Davis replies:*

Mr. Clements' reaction to my article, "Biamplication — Why and How," illustrates the knee jerk response many exhibit when a false belief is challenged.

First: Mr. Clements confuses power consumption vs. power output efficiency as the subject I am discussing. This is possible because of the typographical error in the third paragraph which changed the word "conservation" to "consumption." The sentence should have read, "The law of the conservation of energy is, however, still in force."

The point being made in the first part of my article is that given two 5-watt amplifiers of a given total power of 100 watts, you will not get 200 watts out of them by merely bi-amping, as is claimed by several prominent manufacturers. I quote from a very well-known and respected manufacturer's brochure published very recently, who shall in mercy stay anonymous:

"If the low frequency amplifier is 60 watts and the high frequency amplifier is 30 watts and each operate into 8 ohms, then

$$\begin{aligned} 60 \text{ watts}/8 \text{ ohms has a} \\ \text{peak } V=31 \text{ volts} \\ 30 \text{ watts}/8 \text{ ohms has a} \\ \text{peak } V=22 \text{ volts} \\ \hline 53 \text{ volts} \\ 0.5 \frac{(53)^2}{8} = 175 \text{ watts.} \end{aligned}$$

"175 watts rms! Not bad for a 60 watt rms and a 30 watt rms amplifier. That's the kind of power reserve you get when you biamp."

Mr. Clements says he has not personally seen any such nonsense. Unfortunately, my mail frequently contains such claims. This is the "something for nothing" I referred to in my article and I'm sure that Mr. Clements will agree that using peak voltages to compute "so-called" rms power further compounds the confusion.

I felt that Figures 1b and 2 in the article illustrated that certain waveforms do indeed generate very large voltage swings while developing low powers. (Note that in Figure 2, I point out that if the power were to be calculated from the instantaneous voltage peaks that the average power—calculated from the effective or rms voltage—would have remained at the lower value.)

# Five good reasons

to put your hands on a new Quad/Eight  
"Modular Series" audio mixing console.

The new Quad/Eight Modular Series mixing consoles reflect the identical technology and quality of the internationally accepted custom console line... and are priced to fit every budget.



## 5 NEW MODULAR SERIES MIXING CONSOLES WITH THESE EXCLUSIVE FEATURES

All Console Systems Feature:

- 4 independent, fully equalized echo send/return modules with integral tape delay, meter select, and full program assign.
- Individually switchable Insert patch before or after equalizer.
- Dual phantom power with individual on/off.
- Microphone overload indicators with master threshold preset.
- Standard 5 1/2" and 7" accessory spaces.
- Control room monitor, studio monitor, and communications modules.

All multitrack systems feature two solo circuits; input and monitor/mixdown positional.

All Input Modules Feature:

- 33 frequency, 3 band, stepped equalizers.
- 4 independent echo/foldback sends with individual pre/post, on/off switching.
- Conductive plastic full-travel attenuators.
- Discrete amplifier circuitry in primary signal paths.

**SIERRA**—16 to 36 inputs, plus 4 echo send/return modules, four selectable mixing busses and separate quadraphonic outputs.

**PACIFICA**—16 to 36 inputs, plus 4 echo send/return modules, eight selectable mixing busses, and separate stereo outputs.

**VENTURA**—24 to 36 inputs, plus 4 echo send/return modules, sixteen selectable mixing busses and separate quadraphonic outputs.

**BRENTWOOD**—24 to 36 inputs, plus 4 echo send/return modules, 24 selectable mixing busses, separate quadraphonic outputs and VCA design with 6 sub-groups.

**BEL-AIRE**—24 to 36 inputs, plus 4 echo send/return modules, 24 selectable mixing busses, and separate quadraphonic outputs. Automated fader design with 6 sub-groups, including Compumix III processor.

Please write for complete information on the new Quad/Eight Modular Series.

Circle 34 on Reader Service Card



Quad/Eight Electronics  
Quad/Eight International

11929 Vose St., North Hollywood, CA 91605  
(213) 764-1516 Telex: 662 446

# when the problem is COMMUNICATION



## CLEAR-COM is the solution

SETTING STATE-OF-THE-ART STANDARDS IN THE INDUSTRY for communicating under high ambient noise conditions.

COMPARE THESE FEATURES FOR BOTH PORTABLE AND PERMANENT INSTALLATIONS proven reliability, 30-station capacity, single & multiple channels, call light cueing, one-year unconditional warranty, modular accessories and comfortable headsets to choose from.

Send us your requirements and we will customize a complete modular intercommunications system just for you. Call or write for information.



**Clear-Com**  
INTERCOM SYSTEMS

759 Harrison Street, San Francisco, CA 94107  
(415) 989-1130

Circle 51 on Reader Service Card

# TWO FOR ONE



With the **Sound Workshop 220 Doubler/Limiter** you get two for one.

An electronic delay system capable of delaying audio signals from 5 to 40 milliseconds to give you 2 sounds from 1. 2 voices, 2 drum sets, 2 guitars, 2 anything.

And... a sophisticated peak limiter to add punch to your sounds, and keep a hold on your levels so you can keep a hold on your music.

Two for one—a doubler; a limiter. And of course it's **Sound Workshop** quality. We guarantee it. For 2 years parts and labor.

**The Sound Workshop 220 Doubler/Limiter**  
\$500.

bringing the technology  
within everyone's reach

**Sound Workshop**  
PROFESSIONAL AUDIO PRODUCTS

1038 Northern Blvd., Roslyn, New York 11576

(516) 621-6710

Circle 53 on Reader Service Card

Regarding single sine wave signals (flute solo?) that Mr. Clements refers to, if one listens to organ pedal notes, one will see large value sine wave-like signals appear in the music system. These can and do cause the type of problems that I posed as a theoretical possibility.

Mr. Clements incorrectly refers to my "big guns" as the distinction between coherent and incoherent signals. My "big guns" are the careful demonstration of the transient distortion he prefers to call intermodulation distortion. He further accuses my mathematics of going astray. The equations for combining incoherent signals are from Michael Rettinger's book, *Acoustic Design and Noise Control* and in complete form as shown in Figure 1b for  $E_{TOTAL}$  on page 8 of Mr. Rettinger's book. The equation does not violate Kirchoff's law. I believe that Mr. Clements would like to apply d.c. theory to an a.c. case:

### KIRCHHOFF'S SECOND LAW

*For any closed circuit or any closed portion of a complicated circuit, the algebraic sum of the EMFs and the potential drop is zero.*

*In the practical application of Kirchoff's laws, the correct use of algebraic signs is fundamentally important.*

*In direct-current networks, we used equations based on Kirchoff's Laws which called for adding or subtracting current or EMF values.*

*In alternating-current work, we cannot accomplish this by merely adding the numerical lengths of the vectors.*

*We must instead combine them in such a manner as to take into consideration any phase differences that may exist.*

The above is quoted from *Principles of Electricity*, 1953 edition, by C. F. Myers and L. S. Crosby of The American Telephone and Telegraph Co.

The application of this law in the a.c. case leads directly to the root of the sum of the squares for incoherent signals. To quote further:

*In practice, identical frequency sources having either 180 degrees or no phase angle difference in the two waves is rare. Most commonly . . . a random phase relationship will exist . . . so that the resultant pressures will be  $\sqrt{2}$  times the pressure of each source.*

The above quote is from Mr. Rettinger's book.

A further excellent basic reference for Mr. Clements to reassure himself that the mathematics involved are not my diabolical invention is *Noise in Electronics*, by Courtney Hall, published by Howard W. Sams, pages



# The Audio Travel Lab



## Tektronix TM 500

Here are the four basic instruments you need to check out your electronics. The precision. The versatility. The convenience. They plug in, side by side, in a **TM 515 Traveler Mainframe** that supplies their power and includes storage space for probes and cables.

The Audio Travel Lab features an **SG 502 Audio Oscillator** as a 600- $\Omega$  source of low distortion sine and square waves from 5 Hz to 500 kHz (0.035%, 20 Hz to 50 kHz). The **DC 504 5-digit Counter/Timer** provides precise display of frequency or period for cue and control tone measurements, alignment of filters, and readout of tones from test tapes and records. The **DM 502 Digital Multimeter** provides full-function ac, dc, current, temperature, and resistance readings in addition to dB measurements. The **SC 502 15 MHz Dual-trace Oscilloscope** features Enhanced Automatic Triggering, making it one of the easiest to use oscilloscopes on the market today. It readily reveals clipping and crossover distortion, transients and peak levels, rf interference, and high-frequency oscillations. Reverberation and delay measurements can be made via the

triggered capability with a tone-burst signal. A rear interface circuit board in the TM 515 Mainframe lets you interconnect the plug-in instruments for applications such as gain, loss, or response measurements—at the touch of a push-button.

The TM 515 Traveler Mainframe looks like carry-on flight luggage, but it's really an electronic instrument mainframe and power supply that operates from 48 to 60 Hz, 100 to 240 V ac with a quick-change line voltage selector. It's designed to put lab-quality modular instruments conveniently on the road, to make them easily movable from room to room, useable on a small surface or on end on the floor, or to be easily stashed in the corner out of the way.

Should you have special needs requiring different instrumentation, you can select from the more than 35 plug-in modular instruments of the continually growing TM 500 Product Line. For example, the AF 501 Tunable Bandpass Filter selects a narrow band of frequencies for oscilloscope observation and frequency or level measurement. The AM 502 Differential

Amplifier adds balanced input capability, and its high gain extends noise measurement floors. The sophisticated new FG 504 40 MHz Function Generator features log sweep over the 20 Hz to 20 kHz spectrum and full tone burst capability for delay measurement and transient analysis. The Product Line also includes calibration instruments, power supplies, a logic analyzer, and two sizes of blank plug-in that you may use to build in your own custom circuits. **Just pull one or more of the Audio Travel Lab plug-ins from your TM 515 and insert the appropriate instrument.**

To get full specifications, applications recommendations, and prices, send for the TM 500 Catalog. Circle the reader response number or write or call: Tektronix, Inc., P.O. Box 500, Beaverton, Oregon 97077, (503) 644-0161 ext. 5283. In Europe write: Tektronix Limited, P.O. Box 36, St. Peter Port, Guernsey, Channel Islands.



**TEKTRONIX**  
Committed to  
technical excellence

Circle 52 on Reader Service Card

[www.americanradiohistory.com](http://www.americanradiohistory.com)

# The R.A. Neilson Company.

MARKETING SERVICES FOR  
THE PROFESSIONAL AUDIO  
AND VIDEO INDUSTRY.

• Consultation • Advertising •  
Sales Promotion • Research •  
Industrial Design • Technical  
Writing • Personnel Search.

A technically oriented  
Full-Service Agency.

5001 Laurel Grove Ave.  
No. Hollywood, Ca. 91607  
(213) 760-2010



## Dub faster



## Dub easier

Garner Model 1056 updates your dubbing operation. Five 1200' professional copies in four minutes. Threads fast. Rewinds in 60 seconds. Single capstan drive and solid state electronics guarantee unvarying high quality. Priced low enough for quick payout. Write for brochure and names of users.



**GARNER INDUSTRIES**  
4200 North 48th St.  
Lincoln, NE 68504  
Phone 402-464-5911

Circle 15 on Reader Service Card

48 and 49, wherein the equations for adding noise and signal voltages are developed.

I believe that if Mr. Clements will again read my article and its figures and its true intent, he will find that it is correct and that we are in agreement on:

1. Lowering of distortion is the true benefit of bi-amplification.

2. Effective voltage, or rms voltage, is the proper unit for average power measurement.

3. One can't get more average power out of an amplifier than its true average power rating would indicate.

4. It is possible to find complex signals with crest factors as high as 18 dB (trumpets, for example) wherein all amplification systems need adequate headroom.

I appreciate Mr. Clements' letter; it has afforded an opportunity to further clarify the points made in the article.

DON DAVIS

## Dept. of Corrections

Readers may be interested to know that the recent AES convention report took a lead medal at the proof readers' Olympics. The category was the feature article with the most typographical errors per page. Some were obvious, but unfortunately others may not have been.

For instance, the new Ampex ATR-100 has a signal-to-noise ratio of 69 dB, not 63 dB. And as we reported, the Sound Workshop console is a bargain at \$2850, with twelve inputs and four outputs. But its even more of a bargain the way they deliver it, and that's with twelve inputs and eight outputs. As for spelling Sound Workshop's Mike Colchamiro's name wrong—no apologies. With a name like Colchamiro, what can you expect?

Finally, a letter from Bill Raventos, marketing manager of E-V's pro audio products, informs us that the picture of the Electro-Voice wireless mic system on page 35 of the show roundup is mis-labelled. The E-V wireless mic has a considerably smaller transmitter than the caption indicates. What in fact was shown is the front and back of the receiver. The transmitter is smaller than a package of cigarettes.

## CALENDAR

### OCTOBER

- 11-14 **B&K Seminar; Designing Quiet Products.** Contact: B&K Instruments, Inc., 5111 W. 164th St., Cleveland, Ohio, 44142. (215) 267-4800.
- 26-27 **B&K Seminar: Microphones & Accelerometers: Their Calibration and Use.** (See above.)
- 29- Nov. 1 **Audio Engineering Society Show.** New York City, Waldorf-Astoria. Contact: AES, Room 929, 60 E. 42nd St., New York, N.Y. 10017. (212) 661-8528.
- 26-29 **Microforum '76.** London, England. Contact: British Information Services, 845 Third Ave., New York, N.Y. 10022. (212) 752-8400.

### NOVEMBER

- 7-8 **Convention, Society of Broadcast Engineers.** Holiday Inn, Hempstead, N.Y. Contact: Mark Schubin, Society of Broadcast Engineers, P.O. Box 607, Radio City Station, New York, N.Y. 10019. (212) 765-5100, ext. 317.
- 8-11 **B&K Seminar: Acoustical Materials & Structures: Design, Testing, and Applications.** Contact: B&K Instruments, 5111 W. 164th St., Cleveland, Ohio 44142. (216) 267-4800.
- 8-12 **National Automated Production Exhibition.** Manchester, England. Contact: British Information Services, 845 Third Ave., New York, N.Y. 10022. (212) 752-8400.
- 9-11 **Synergetic Training Seminar.** Nashville, Tenn. Contact: Don Davis, Synergetic Audio Concepts, P.O. Box 1134, Tustin, Ca. 92680. (714) 838-2288.
- 17-18 **Marketing Strategies for Selling to the U.S. Telecommunications Industry.** Royal Kensington Hotel, Kensington, London, England. Contact: Bob Sanzo, Director of Marketing, Frost & Sullivan, Inc. 106 Fulton St., New York, N.Y. 10038 (212) 233-1080, or Bonnie Durrance, Frost & Sullivan, Inc. 13 Rue Maitre Albert, Paris 75005, Tel. 633-04-06.
- 17-19 **Synergetic Training Seminar.** Orlando, Fla. Contact: (See above.)

### DECEMBER

- 6-10 **Industrial Noise Control, B&K Seminar.** B&K Instruments, Inc. 5111 W. 164th St., Cleveland, Ohio 44142. (216)-267-4800.

## octave equalizer

Dyna's new SE-10 Equalizer will astonish the experts who have rejected the sound coloration of other designs. The SE-10 is probably *the finest sounding equalizer*—certainly at its cost.

It's easier to use, more tolerant, (forget overload, switch pop, and unity gain problems) and has greater versatility. Two separate line in/out pairs, plus tape monitor on one (12 jacks).

No inductor saturation, with a hybrid concept utilizing new design IC-simulated inductors at the four low frequencies, and superior performance gapped pot core inductors above 300 Hz, with all polyester control circuit capacitors.

8 ICs, 2 FETs, 5 transistors; IC-regulated power supply; 600 ohm output; typical distortion below 0.01%. Dynakit construction with a single pre-assembled circuit board is fast, easy and fun. Compact Dyna size. Optional wood cabinet shown; rack-mounting accessory panel kit available.

Suggested list \$249 kit \$349 assembled



# new dynaco pros

## mark VI amplifier

The beauty is in the sound. A new mono tube amp for getting the pro's job done *right*. Sturdy, reliable, easy to service, readily available parts of the highest quality. Perfect for discos, instrument amplification, and contract use. The best solution for all types of difficult installations.

The output transformer is the key to the performance of every tube amplifier. Dynaco transformers have been world famous for more than 20 years, and this latest computer-designed version in the Mark VI alone weighs 19 pounds! 120 watts into 4, 8 or 16 ohms at low distortion; recessed front controls for input level, bias adjustment, and the large lighted meter which reads bias or output; front speaker fuse; time delay relay; added XLR input and phone jack output; frequency response 10 Hz to 40 kHz, +0, -1 dB; hum and noise more than 95 dB down; 1/8" steel rack-mounting panel; less than 10 hours to complete the kit.

Suggested list \$425 kit \$649 assembled



Write Bob Tucker Dept. DB, Box 88, Blackwood, N.J. 08012

**dynaco**  
**dynakit**

Circle 16 on Reader Service Card

www.americanradiohistory.com



**Six different audio DA's designed to solve all of your distribution problems.**

From our table top 1 in/6 out to our powerful 20 in/80 out. Stereo or mono operation, output metering, individual level controls and balanced inputs and outputs are just a few of the many features found in these superb DA's. Performance? Response — 10 Hz - 20 KHz  $\pm 0.5$  db; Dist. — 0.1%; Output level — +20 dbm max; Signal/Noise — -90 db; Channel separation — 80 db. Quality? All RAMKO products are backed by our 10 day free trial and 2 year warranty. They have to be good to do that.

Call collect or write today!

**Models & Prices**

DA-6/E 1x6 (table top) . . . . .	\$ 145
DA-6R/E 1x6 (rack) . . . . .	\$ 165
DA-6BR/E 1x6 (rack, indiv. cont.) . . . . .	\$ 179
DA-6RS/E 2x12 (rack) . . . . .	\$ 239
DA-16BR/E 2x16 (rack, meter, etc.) . . . . .	\$ 295
DA-2080 up to 20x80 (rack) . . . . .	\$325 - \$1,675

**RAMKO RESEARCH**

3516 C LaGrande Blvd.  
Sacramento, California 98523  
Telephone (916) 635-3600

Circle 31 on Reader Service Card

• We have discussed the use of crossovers, so far on the assumption that the filters do what the design says they will do. I mentioned that this assumes they are loaded with a resistive impedance specified in the design. This means that a 16-ohm loudspeaker unit would have an impedance that looks like that of a 16-ohm resistor, which we know it does not.

What does an average loudspeaker impedance actually look like? In answer to this, we will usually show an impedance curve, such as in FIGURE 1. But what does this curve mean? How was it taken? If the unit is designed to reproduce the lower frequencies, is the impedance taken with it in an enclosure, or just as a unit?

To see why this question is important, we suggest you take some kind of loudspeaker unit—just a cheapie will do to show what we mean—and connect it up as shown in FIGURE 2. The audio generator will supply any frequency you want, which is amplified and supplied, through a small value resistor to enable you to measure current, to the unit. Then you apply the voltage picked off across the current-measuring resistor to the horizontal deflection of a 'scope while the voltage across the coil goes to the vertical deflection.

The effect may be even more dramatic if you use a larger value resistor—say 100 ohms—so the unit is fed more like constant current than the usual constant voltage. As you sweep frequency, you will observe a trace that changes shape, from a sloping line to an ellipse that tilts and changes proportions rather wildly.

The fundamental resonance of the unit will be fairly easy to find. It will be a sloping line, at a steeper angle than any of the traces show. If you use a low value resistance, the height will not change much, but the width will; the line will be steep because the horizontal input gets very small. If you use a larger value resistance, the width will not change much and the line will be steep because the vertical input gets much

larger than at other frequencies (FIGURE 3).

Now, assume you found this with the unit lying on its back and the cone pointing upward, away from the bench. What you are looking at is its unmounted impedance. With it set to the resonance frequency, pick up the unit and turn it over, placing it so the edge of the bench "loads" it, partly on, partly off (FIGURE 4).

The first thing you will notice is that its audible output increases when you do this and that the line you had set on the 'scope now opens out into an ellipse. The change is quite marked. If you hold the unit in that spot, now change the frequency and adjust it until you again find a resonance.

You will find the resonance at a frequency lower than it was before. The air loading has increased the mass that the cone must move. Is the sloping line steeper, or not so steep, as it was with the unit the other way up? Not only does the frequency of resonance change, but its dynamic impedance will change too, one way or the other, as a rule.

**BASS RADIATION**

Perhaps you have a box for the speaker, with a hole in the front, in which the unit mounts, and a removable back. Try putting the unit into its mounting hole, with the removable

Figure 1. Typical loudspeaker impedance curve: A. Curve rising with frequency, inductive reactance; B. Main resonance, resistive; C. Curve falling with rising frequency, capacitive reactance; D. Lowest value, resistive; E. Curve rising with frequency, inductive reactance.

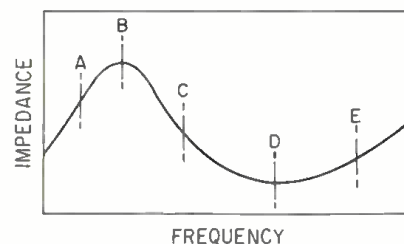

# Tune-up, Preset and Change Scenes. In Real Time.

The Series 20A offers great flexibility in theatre sound mixing, television production, and concert sound reproduction.

The Series 20A is totally modular. That means you can have custom convenience at off-the-shelf prices. Because modularity lets you purchase only the modules you need. As your needs expand, you simply plug in more modules. And you can customize the arrangement for a particular show. Just plug the modules into any position on the chassis. No tools required.

The Series 20A simplifies your real time operation by allowing you to predetermine program content and distribution. Designed with human engineering in mind, the following features are provided.

- 4 chassis/enclosure sizes: 2½' with 21 module positions, 4' with 31, 5' with 39, and 6' with 47 positions.

- Up to 37 input channels, each switch selectable for mic and line level signals. Optional switching modules for selection of up to 48 additional remote inputs.
- Presettable (mute) circuit for each of four independent pre-sets. Any input can be assigned to any combination of the four muting circuits. Allows instantaneous changeover from one "scene" to another.
- Two complete foldback buses having level and switching controls at each input, with sub master controls.
- 3-Knob equalization on every input channel—with boost or cut.
- Unique datacable and roadmap configuration to interconnect Cetec's all solid-state printed circuits. Straightforward design provides simple plug-in module positioning.

For further information, contact Cetec Audio

A division of Cetec Corporation.

13035 Saticoy Street

No. Hollywood, CA 91605

Phone: (213) 875-1900 TWX: 9104992669

A division of Cetec Systems LTD.

U.K. Sapphire House, 16 Uxbridge Rd., Ealing,

London W52BP

Phone: 01-579-9145 Telex: 837329

## Cetec audio

For the educated ear.

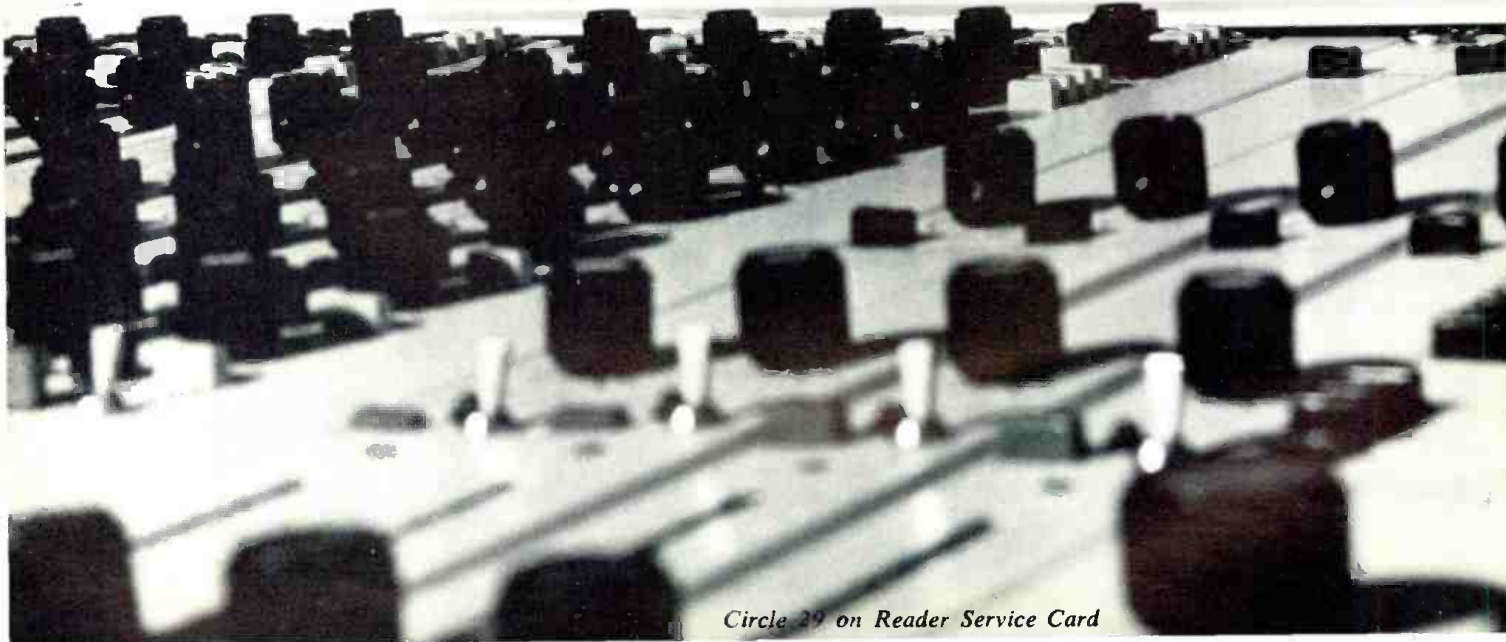
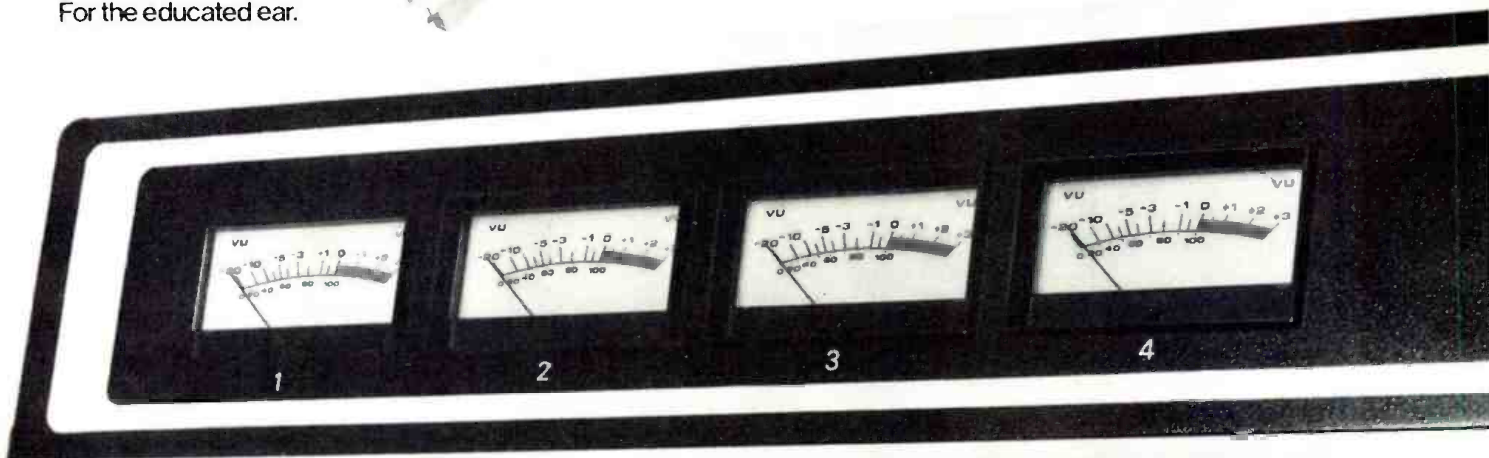
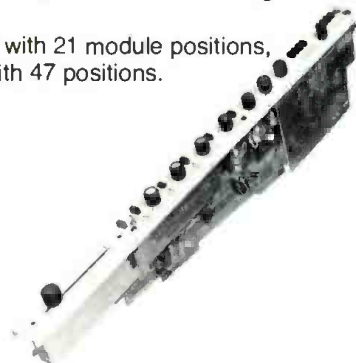

Circle 29 on Reader Service Card

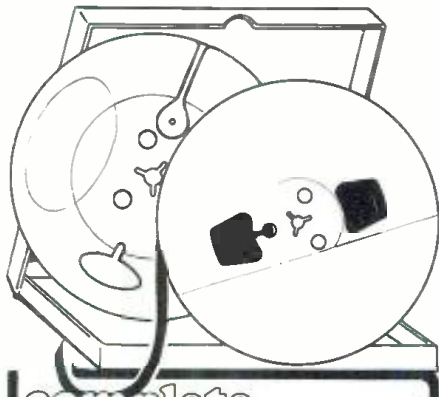

## complete supplies for reel to reel audio recording

- TAPE** AMPEX and Scotch all professional grades on reels or on hubs
- EMPTY REELS** all sizes, widths and hub types
- BOXES** for all reels, in various colors
- LEADER-, TIMING- & SPLICING TAPES**

Top Quality Competitive Pricing  
Immediate Shipment  
Call or Write for Details/Prices



**Recording supply corp.**  
1291 RAND RD - DES PLAINES, IL 60016  
312/297-0955

Circle 46 on Reader Service Card

## Erase faster



## Erase cleaner



## Erase easier



**Garner Erasers** cut man-hours spent erasing audio and video tapes. Simple, safe continuous belt operation gives you "hands-off" professional erasures in only four seconds. Handles up to 10½" reels, cartridges, and cassettes. Acclaimed by major users, yet priced low enough for the smallest studio or station to afford.



**GARNER INDUSTRIES**  
4200 N. 48th St.  
Lincoln, NE 68504  
402-464-5911

Circle 48 on Reader Service Card

## theory & practice (cont.)

back off. The effect will be not unlike that of putting the speaker over the edge of the bench. Bass radiation is improved and the change in resonance is in the same direction—lower in frequency. Fasten the unit in place.

Now put the back of the box in position and see how the impedance trace changes again. This time, resonant frequency will go higher, possibly higher than it was unmounted. This will depend on the size of the box, relative to the size of the unit and its particular design. If it is of the sloppy variety known as acoustic suspension the speaker's resonance, unmounted, will be quite low. Mounted in its box with the back off, it will be a little lower. But with the back in place, the resonance will go up considerably because the main stiffness contributing to its control will be the air enclosed in the box.

If you have bass reflex, or vented enclosure, you can find even more variations in impedance characteristic. Everything you change will change the impedance characteristic.

This kind of experimentation should give you a feel for what happens impedance-wise, particularly how changing the acoustical environment of the units reflects into its electrical impedance. But now, what does this mean in terms of providing the necessary electrical drive for it?

If you use a larger value resistor, such as the 100 ohm unit I suggested, you will see that resonances are pronounced. You may even be able to detect the after-ring if you drive the unit at its resonant frequency, and then cut off the oscillator suddenly. The horizontal deflection will terminate when you cut the oscillator input, but the vertical will die down noticeably later.

If you use a small value resistor, say 1 ohm, the after-ring will be much reduced, signifying that the resonance is better damped, providing the amplifier you use for driving it

has a low output source resistance. If not, you may still note a die-away. With a low output source resistance, which used to be called a high damping factor, the amplifier output circuit short-circuits the voltage generated by the unit after the drive is removed and thus damps further movement.

## ADJUSTING FREQUENCY

Although anything you change in the unit's acoustical environment alters both its frequency response and its impedance characteristic, do not make the mistake of thinking the impedance characteristic can be used to indicate what happens to frequency response.

Take what happens at the unmounted resonance when you either mount the unit or load it by putting it against the bench. Unmounted, the cone will make a maximum excursion at resonance. This excursion is what produces a larger voltage at that frequency than at frequencies above or below resonance.

Now, you load the cone, by putting it in its mounting position or whatever, and the cone movement is reduced, increasing the acoustic output because the mounting helps to radiate sound at that frequency. Because movement is reduced, drive current rises so that for the same drive voltage, the unit takes more energy at that frequency, which is no longer resonance.

When you readjust frequency to the new resonance, everything changes again. If you have a vented enclosure, reasonably well matched to the unit, the impedance curve will have two peaks, separated by a trough. At the upper peak, the air in the vent will be moving forward at the same time the cone is moving forward and a resonance effect will cause maximum cone movement for the drive provided.

At the lower peak, air in the vent will be going the reverse way from the cone movement, so there will be some cancellation in radiation at this frequency. But radiation will be extended below the upper impedance

Figure 2. Arrangement for displaying loudspeaker impedance as varying loop or line.

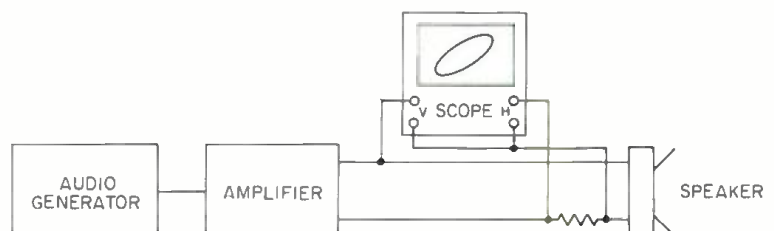

# Powerful alternative.

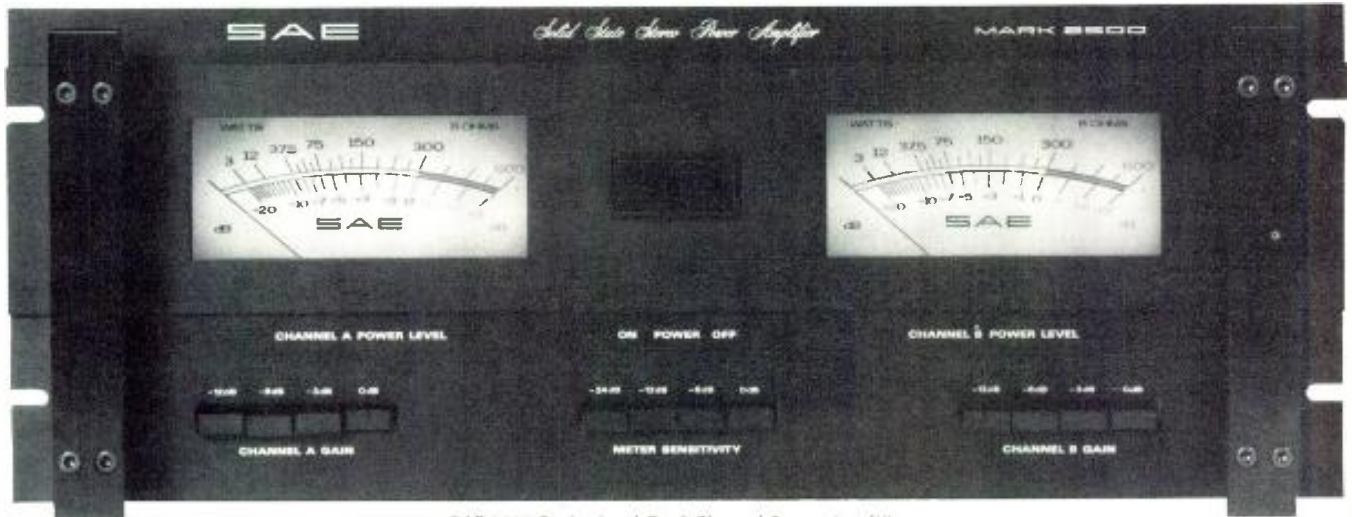

SAE 2500 Professional Dual-Channel Power Amplifier

When you compare power amplifiers, you have to look at the hard facts. The SAE 2500 Professional Dual-Channel Power Amplifier has them—top power, specifications, reliability and features that make it the most "powerful alternative."

**Power.** 450 Watts RMS per channel, both channels driven into 4 Ohms from 20Hz to 20kHz at no more than 0.1% total harmonic distortion. Or, 300 Watts RMS per channel, both channels driven into 8 Ohms from 20Hz to 20kHz at no more than 0.05% total harmonic distortion.\* Plus, a new, smaller wide-channel power transformer coupled to 4 computer-grade capacitors for a power supply that varies no more than 10% from no load to full load. (For extra protection, there are relay and thermal cut-out devices.)

#### Other Specifications:

IM Distortion from 250mW to rated power at 4 or 8 Ohms with any 2 mixed frequencies between 20Hz and 20kHz at 4/1 voltage ratio.....0.05 Max.  
 Frequency Response at rated power..... $\pm 0.25$ dB, 20Hz to 20kHz  
 Noise.....Greater than -100dB below rated power  
 Transient Response of any Square Wave.....2.5 $\mu$ sec. rise and fall time  
 Slew Rate.....40V/ $\mu$ sec.  
 Dimensions.....Front panel: 19"Wx7"H, Chassis: 15 $\frac{1}{2}$ "D (excluding handles, controls and connections)

\*These specifications comply with FTC requirements for power amplifiers.

**Reliability.** The SAE 2500 gives you high current capability with Parallel-Series-Output Circuitry (PSO)—without loss of wide power bandwidth, low leakage current or super-high slew rate. Sixteen triple-diffused output transistors have an electrical and thermal SOA 50% higher than maximum design requirements for reliable high demand capability. This configuration can handle anything from continuous full signals to highly reactive surge loads—all day long without failure or overheating. Dual relay disconnect circuits and plug-in board design further assure reliable performance.

**Features.** Feedback level controls assure a constant input impedance of 50k Ohms and reduce the noise figure to more than 100dB below rated output in all positions. Loudspeaker protection relay-activated circuit automatically disconnects speakers in case of  $\pm$ DC outputs. Plus, direct power reading VU meters and forced air cooling.

The SAE 2500 Professional Power Amplifier weighs only 58 lbs. making it practical for portable sound reinforcement, public address, communications and recording applications.

## The professional alternative.

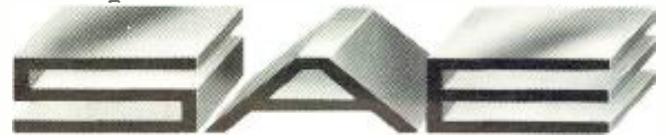

Scientific Audio Electronics, Inc.  
 P.O. Box 60271  
 Terminal Annex  
 Los Angeles, California 90060

Please send me the reasons (including available literature) why the SAE 2500 Professional Dual-Channel Power Amplifier is the Powerful Alternative

Name \_\_\_\_\_

Address \_\_\_\_\_

City \_\_\_\_\_ State \_\_\_\_\_ Zip \_\_\_\_\_

2500 INTERMODULATION DISTORTION @ 8 OHMS, FULL POWER 49V RMS BOTH CHANNELS DRIVEN

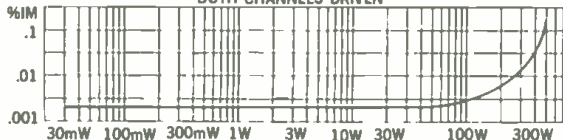

2500 TOTAL HARMONIC DISTORTION @ 8 OHMS, FULL POWER 49V RMS BOTH CHANNELS DRIVEN

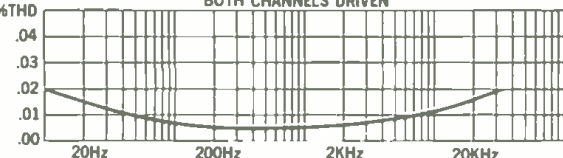

Circle 35 on Reader Service Card

**Tomorrows  
Audio  
Consoles...**



**... here today!**

**The biggest advance of audio control in the last 15 years.**

Totally DC controlled for noiseless switching and audio mixing. Lighted touch pad switching eliminates mechanical noise and breakdown. Advanced solid state light emitting "VU" meters. Cermet mixers and level controls for years of trouble free operation. Plug in amplifier cards. Full range input gain select from mic thru high level. All inputs and outputs balanced. Distortion — 0/3%; Response — +0, -2 db, 20 Hz - 20 KHz; Noise — -65 db (mic inputs). Flexibility? Complete complement of accessories for input expansion, equalization, remote control, etc.

10 day free trial and 2 year warranty.

Call collect or write today. You'll find it both an exciting and profitable adventure!

**Models & Prices**

SC-5M Single Channel, mono . . . . .	\$ 780
DC-5M Dual Channel, mono . . . . .	\$1032
DC-5MS Dual Channel, stereo . . . . .	\$1252
DC-8M Dual Channel, mono . . . . .	\$1390
DC-8MS Dual Channel, stereo . . . . .	\$1880

**RAMKO RESEARCH**

3516 C LaGrande Blvd.  
Sacramento, California 95823  
Telephone (916) 635-3600

**theory & practice (cont.)**

peak due to the drop in impedance in the trough, allowing the unit to take more drive current.

Thus the overall response results from combining the electrical coupling from the amplifier, which depends on how the unit's impedance varies with frequency, with the electro-acoustic conversion efficiency of the unit, in its enclosure, at various frequencies, and finally with the acoustic response of the radiating structure. This depends on the relative phase of the different components of movement, particularly in the case of a vented enclosure, commonly called a bass reflex.

**CROSSOVER DESIGN**

Now, what we started out to discuss was the use of crossover networks. Getting back to that, how does the variation of loudspeaker impedance affect crossover design? As I said earlier, undulations in impedance characteristic well within the pass range of the crossover network used do not affect its performance materially. To all intents and purposes, the network just connects the voice coil to the amplifier over this range, so any changes in impedance are reflected straight back to the amplifier as if the crossover network was not there.

Where it can make a difference, is at the point where you approach crossover frequency. Looking at the impedance curve of FIGURE 1 again, the unit looks almost as if it produces a pure resistance, where the curve touches bottom. Below that frequency, where the curve is still going down from the top side of resonance, the unit has an impedance that includes capacitive reactance. Above that frequency, where impedance starts to rise again, it is inductive, mainly due to voice coil inductance.

But your crossover network does not care what causes the impedance. It only knows that the impedance consists of resistive and reactive components that will change its response from that predicted for just resistive termination. The change can include some spurious kinks that you did not plan on being there, or you can plan to use the impedance of the loudspeaker as part of the crossover function.

These effects all depend on where you put crossover frequency, relative to the impedance characteristic of the loudspeaker unit. If you want to avoid unwanted kinks, you had better plan on using the loudspeaker's own impedance as part of the circuit.

The best way to do this is to arrange for the crossover frequency to

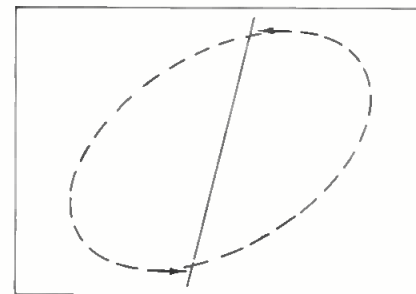

(A)

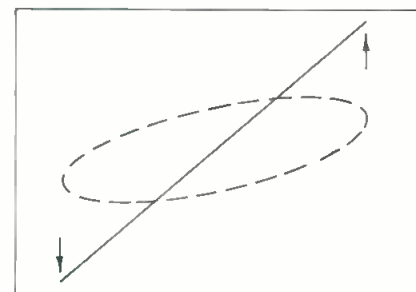

(B)

Figure 3. Two ways that main resonance can be shown: (a) with small series resistor ( $\cong 1\Omega$ ); (b) with large series resistor ( $\cong 100\Omega$ ).

Figure 4. Placing unmounted loudspeaker unit to produce partial loading.

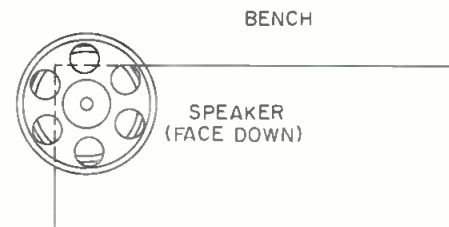

be where the impedance is beginning to rise, above the lowest part of its curve. If you go too far above this point, even if the response is maintained that far, the impedance will be getting close to being mainly inductive, with little resistive component, a condition which will invalidate the crossover's response predicated on a resistance load.

You should pick a point where the impedance is not more than about root-2, or 1.414 times its minimum value. Then you can figure the equivalent inductance component of the unit, in the vicinity of crossover frequency, and compensate for it in the design of the network. More of that next time. ■

**Copies of db**

Copies of all issues of **db—The Sound Engineering Magazine** starting with the November 1967 issue are now available on 35 mm. microfilm. For further information or to place your order please write directly to:

**University Microfilm, Inc.**  
300 North Zeeb Road  
Ann Arbor, Michigan 48106



Each of these  
new Peavey Mixers  
costs less than \$1,000.

How do they stack up  
with the competition?

Have a  
look.

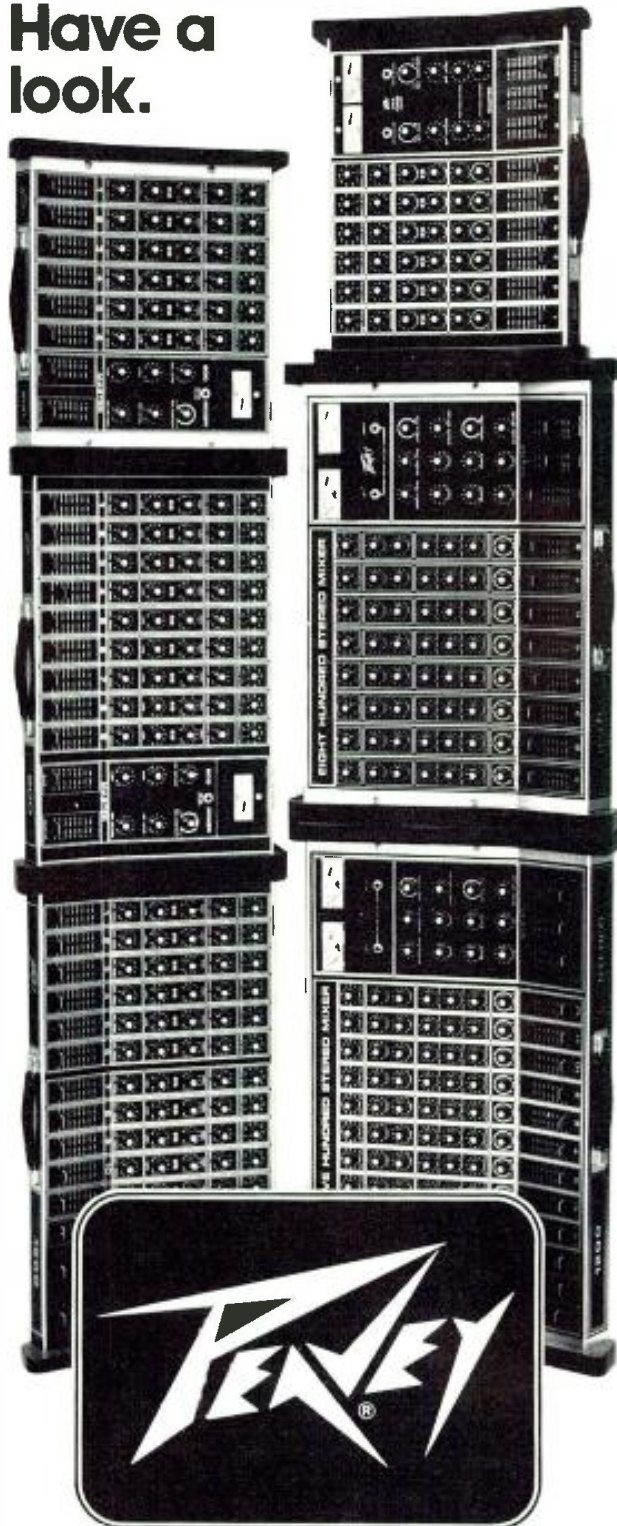

These new Peavey Mixers have been designed to satisfy the requirements of a continuously variable sound reinforcement market. If your requirements are stereo, mono, high impedance, low impedance, balanced, or unbalanced,...we've got a mixer for you.

We offer as standard equipment such features as input attenuation variable to -40 dB, pre monitor, post effects with built-in reverb, effects return, and slide faders on even our most inexpensive mixer.

Comparison of distortion figures, frequency response, noise performance, and functional features will illustrate the tremendous value of these mixers.

## 600 Mixer

6 channel Mono, with 6 low Z, 6 high Z, & 3 auxiliary inputs  
20 Hz to 20 kHz response with less than 0.1% THD  
-123 dBV equivalent input noise  
5 volts RMS out  
Price: \$349.50

## 600S Mixer

6 channel Stereo, with 6 low Z, 6 high Z, & 4 auxiliary inputs  
20 Hz to 20 kHz response with less than 0.1% THD  
-123 dBV equivalent input noise  
Stereo pan each channel  
Effects return with pan  
5 volts RMS out  
Price: \$424.50

## 800S Mixer

8 channel Stereo, with 8 low Z, 8 high Z, & 5 auxiliary inputs  
20 Hz to 20 kHz response with less than 0.1% THD  
-126 dBV equivalent input noise  
Stereo pan each channel  
Effects & Stereo return with pan  
Left & right Main and Monitor outputs transformer balanced  
4 volts RMS out  
Price: \$649.50

## 900 Mixer

9 channel Mono, with 9 low Z, 9 high Z, & 4 auxiliary inputs  
20 Hz to 20 kHz response with less than 0.1% THD  
-123 dBV equivalent input noise  
5 volts RMS out  
Price: \$449.50

## 1200 Mixer

12 channel Mono, with 12 low Z, 12 high Z, & 4 auxiliary inputs  
20 Hz to 20 kHz response with less than 0.1% THD  
-123 dBV equivalent input noise  
5 volts RMS out  
Price: \$549.50

## 1200S Mixer

12 channel Stereo, with 12 low Z, 12 high Z, & 5 auxiliary inputs  
20 Hz to 20 kHz response with less than 0.1% THD  
-126 dBV equivalent input noise  
Stereo pan each channel  
Effects & Stereo return with pan  
Left & right Main and Monitor outputs transformer balanced  
Transformer balanced inputs  
5 volts RMS out  
Price: \$999.50

All prices are manufacturer's suggested retail.  
Because of freight and duties, export prices are slightly higher.

For complete specs and information on any of the new Peavey professional Mixers write:

Peavey Electronics, Corp.  
Post Office Box 2898  
Meridian, Mississippi 39301

Dear Mr. Woram:

Somehow your column in the May issue of *db* struck me as being a little poorly thought out. The simple fact of the matter is that the companies that supply guitar amplifiers don't make equipment that meets up to the lofty standards you set in the first paragraph of your response to that guy's letter. This has nothing to do with amps going "sour;" it's just that 99 per cent of the applications for this equipment are not as noise-sensitive as the environment of a recording studio, and the design parameters are set accordingly.

With the exception of the Les Paul "recording" models, virtually all guitars and related equipment are high impedance unbalanced system and do not make for low noise sound, especially since virtually every contemporary guitar player wants distortion in

his signal and, due to the way things are, either gets it from a small transistorized box, or a large, noisy tube amp. Your remarks in paragraph three really amazed me. To say that "the pro would opt for an acoustic (guitar)" is so totally out of touch with the whole business of playing guitar, as to make me wonder about your qualifications to run around making these accusations of unprofessionalism about contemporary musicians.

To reiterate, the state of music today calls for distortion, and the equipment provided musicians just can't provide that without related noise. The best example I can give you is my own amplifier. It's hand-made by a couple in California, and uses a stack of tube preamp stages to create controlled distortion. (It's a Mesa Boogie Super Sixty amp. \$395, plus additional charges for options—JMW). It

cost me a lot of money, and it took them four months to get it to me. The springs on the reverb are exposed, so when you play it at low volume you can hear them rattle from having the program pass through them. It is subject to fits of high frequency noise, but it sounds like god on wheels and every time I play it I flip out all over again about what rich overtones and great sustain it gives me. And that's not unprofessional. The same amp is used by John-McLaughlin, Carlos Santana, Chick Corea, Lee Michaels, etc. It is a fact of life that this equipment produces noise, and to get into an attitude where you start knocking musicians for unprofessionalism, or ask them to play acoustically (that still knocks me out) is unrealistic and counterproductive. I hope you see my point.

J.E.

Looks like I've done it again! Yes, I see your point, but I think you (and others) missed mine, maybe because it was poorly thought out.

Let's go back and start at the beginning, with a look at the guitarist and his amplifier. I'm no authority, but I'm sure that the musicians you mention do indeed spend 99 per cent of their playing time ( $\pm 3$  dB) in non-studio environments—concerts and such. They need amplifiers that will give them the kind of sound they want on stage, like your Mesa Boogie. If a little noise comes along with the gorgeous sound, you're right again; it's really not that important.

But now, we come to that 1 per cent of the time, in which the musician goes into the recording studio and discovers a totally different environment. Or at least we hope he discovers the different environment. Gone are the stage, the p.a. system, the crowds, the lights, the visual stimulation, AND the power handling requirements. In short, the whole concert ambience has been wiped out. The visual props, the glitter and the far-out clothes aren't going to do a damn thing to help the recorded sound. And neither is an amplifier that will peel the paint off the walls at 150 yards. If your whole act depends on most of the above, you're going to be in big trouble, for the microphone sees nothing, yet hears, and worse yet remembers, everything.

#### RECORDING STUDIO AMBIENCE

So, it makes no difference whether you're a superstar or a beginner. In the recording studio you must approach your music from an entirely different direction. Some musicians don't understand the difference between the concert and the studio performance. So, engineers spend a lot of

## In 16 years, more than 300 studios have chosen our tape duplication system.

### Here's why they made the right choice.

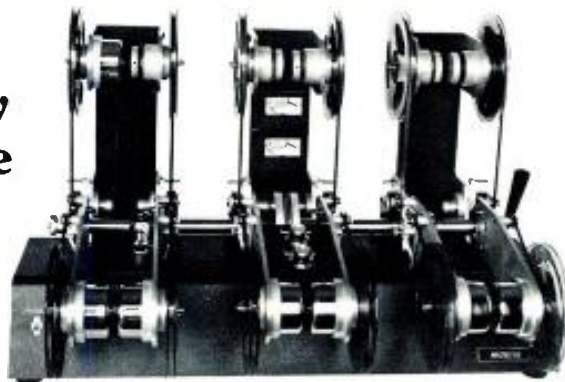

Since 1960, the Magnefax tape duplication system has delivered high performance, long service life and low cost to the professional studio.

Our new model does an even better job. Five simultaneous copies are made at 60 IPS to professional standards. All head configurations are available. One model will duplicate bulk cassette tape. And for best reproduction, our high speed bulk eraser gets you off to a clean start.

We've made the system so efficient, so easy and so good, you'll agree that when you need faithful reproduction, you need Magnefax.

**mmmm**

**magnefax** inc.

Formerly of  
Lincoln, Nebraska

RFD 1, Rogers, Ark. 72756, 501/636-5770

Circle 20 on Reader Service Card

# Soul trio in Studio A. Beethoven's 5th in B. Rock concert in the park.

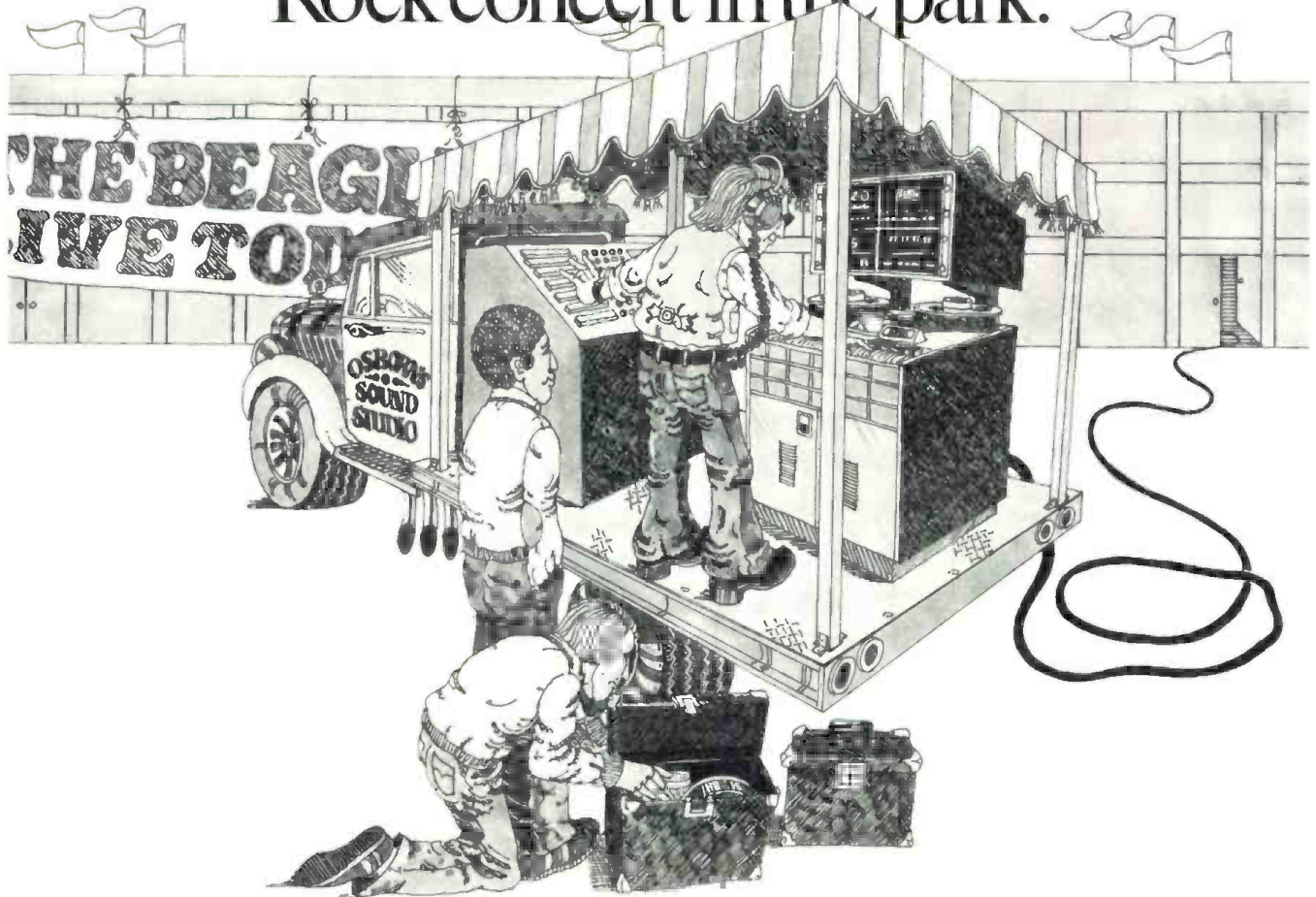

## MM-1200 gets around.

The best multi-channel audio recorder in the world is also the most versatile. It handles 16-inch reels of two-inch tape for 16 or 24 channel work, and does a beautiful job with an 8-track head and one-inch tape. It'll give you the flexibility to record a vocal quartet one day, and a full orchestral ensemble the next.

You'll probably buy



your MM-1200 for the ruggedness built into it. Roll it from studio to studio, truck it around town, shift it in the booth, it'll stay aligned. And when it comes to maintenance, the MM-1200 is an open book to any service technician.

But after you have an MM-1200 working for you, it'll be a real breadwinner.

Engineers love to work MM-1200 sessions because the machine is easy to control and set up, producers love the way each channel is crisp and isolated, and accountants love the way our multichannel machine keeps returning profits on the original investment.

MM-1200 is the multi-channel audio recorder from Ampex, for studios that can't take chances.

### AMPEX

Complete technical and performance specifications are available in a free brochure. Write us at 401 Broadway, Redwood City, California 94063, or call (415) 367-2011.

Circle 18 on Reader Service Card

[www.americanradiohistory.com](http://www.americanradiohistory.com)

# ALPHA 21 TOMORROW'S CASSETTE COPIER TODAY



Everything about the ALPHA 21 Cassette Copier implies professionalism. From its stylistically sloped cabinet to the tape transport construction and electronics design, this copier will become the industry standard.

Built along digital transport lines, the ALPHA 21 is the only copier in the industry utilizing a rigid 1/8 inch deck plate that will not twist. It uses a five motor drive to eliminate troublesome belts and pulleys. Circuit boards are all plug in.

ALPHA 21 will duplicate a half hour cassette in less than one minute. More important, it is the only low priced copier that will take two position slave add-ons (as pictured).



Many exclusive features are built into the ALPHA 21. Before you make any purchasing decision, you owe it to yourself to find out what this copier has to offer. For detailed information, call or write:

## DUPLICATOR CASSETTES

We have a full line of premium cassettes designed for high speed duplicator applications, available in exact lengths, bulk, or boxed and labeled. We also offer blank cassette labels and boxes. Write or call for brochures.

## INTERNATIONAL AUDIO, INC.



Professional Products Division  
2934 Malmo Drive  
Arlington Heights, Ill. 60005  
(312) 956-6030

Circle 38 on Reader Service Card

# Listen to wow and flutter.



If you service record/playback equipment, you need to measure wow and flutter. And with the BPI Model 1000A, you can listen to wow and flutter as well. Because right between those needle meters is a speaker to help you diagnose the problem. The Model 1000A is an easy-to-use, all-solid-state pushbutton instrument that measures wow and flutter to 0.02%. And it's priced at under \$650.



BPI, 7853 Balboa Ave., San Diego, Ca. 92111, Phone (714) 279-3344

Circle 36 on Reader Service Card

## the sync track (cont.)

their time, and the producers' money, trying to make adjustments for—among other things—amplifiers that don't belong in the studio in the first place. Much of this time and money can be spent more creatively once the musician learns about those differences.

Now this has nothing to do with the player's professionalism—as a musician. But many great musicians get wrecked in the studio because they think they are still on stage. So, regardless of what you think of my qualifications, IF a contemporary musician refuses to open his eyes—and ears—to the demands of the recording studio, he is no pro. Note that I did not say that *all* contemporary musicians *must* play acoustically at all times. I did say, or meant to say, that all electric musicians might consider pulling the plug if—and only if—their amplifiers are wrecking the session. That's a hell of a lot more creative than asking the engineer to cover up a lot of electrical sins, and I still say the real pro would never think of doing so. At least, not as "standard operating procedure." Looking at it from the other side, would *you* tolerate an engineer who asked you to play loudly to cover up the noise coming out of his console?

## PRACTICE AMPLIFIER

Of course, I'm not knocking the just-getting-started musician who can't afford a more suitable amplifier. He'll do the best he can with what he has, and the engineer will (I hope) do everything he can to help out. But as the musician develops, he'll eventually discover that the super amp he bought for on-stage work may not be doing him any favors in the studio. In many cases, a little practice amplifier (Pig Nose Industries, or similar) may give him all the distortion he needs, without the ambient noise level of the heavy artillery-type amps. You can get one for less than \$75, which is a lot less than the price of a noise gate.

So, my complaint is with the musician who rolls in enough power to do arc welding, and then expects the engineer to "fix it" when it gets too noisy. Maybe the engineer *can* fix it with gain riding, noise gates and such, but why not avoid the problem in the first place? All you have to do is remember that the studio is not the stage, and either use a different amp, get the one you have fixed, or, horror of horrors!—go acoustic.

This next letter (addressed to the editor) is really depressing. I wonder how it strikes most readers?

JBL MODEL 4315 STUDIO

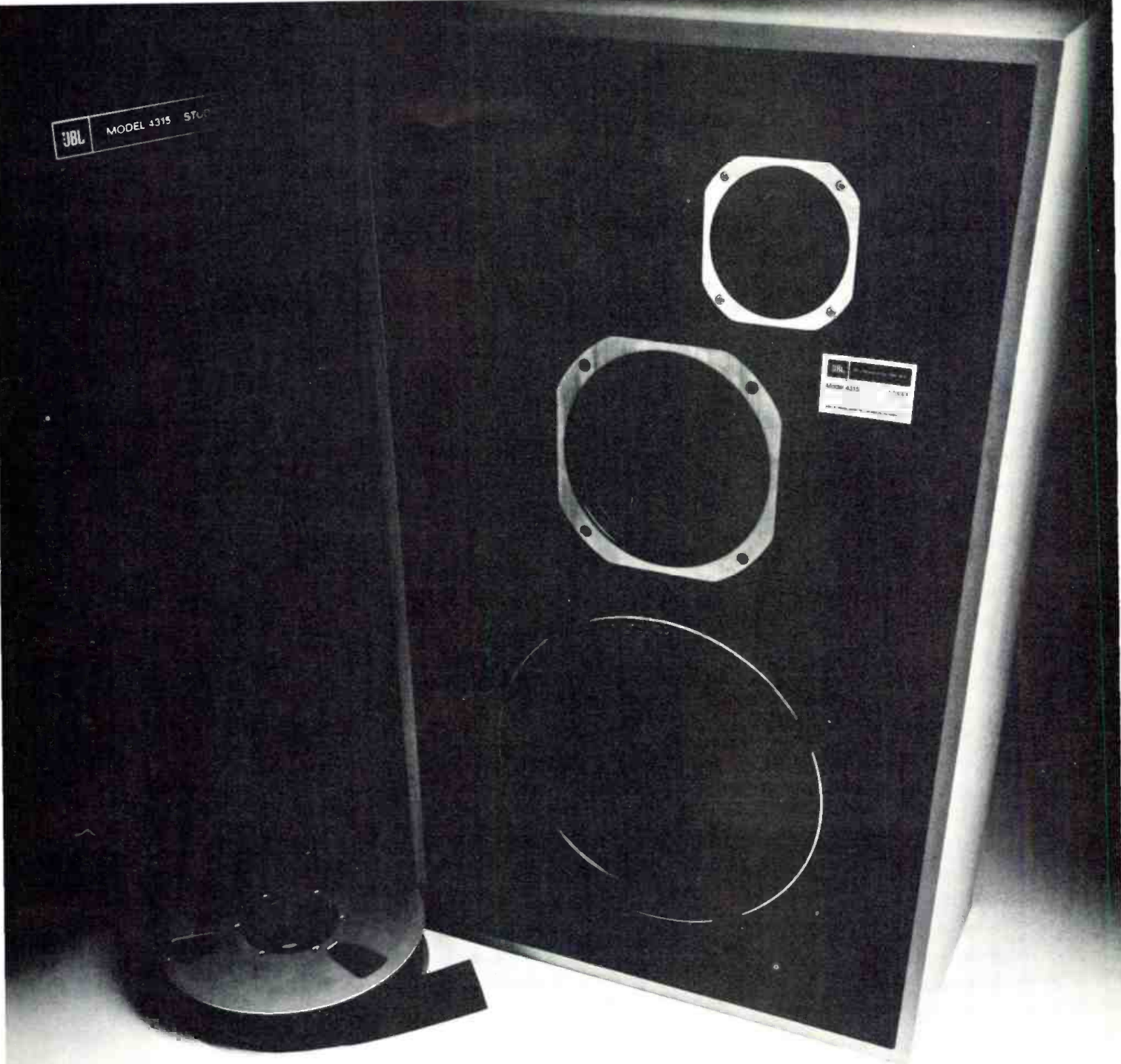

JBL's new 4315.  
There's never been a wider range  
studio monitor. Of any size.

And, four more things:

It's a four way system. It has the most sophisticated cross-over network ever designed. It's compact, shallow, portable. Perfect for wall mounting, horizontally or vertically. It's yours for \$714.

There's more. Much more. Go hear the rest.

Circle 30 on Reader Service Card

James B. Lansing Sound, Inc., 8500 Balboa Blvd., Northridge, Calif. 91324.  
[www.americanradiohistory.com](http://www.americanradiohistory.com)



## the sync track (cont.)

As you know, there are not many magazines devoted to the engineering and production side of audio recording, and none that carry much information for the many basement studio operators that are now springing up everywhere. My complaint at that lack is not going to produce more articles so I'll say no more. I do have a complaint that is rational and that you have the ability to act on.

The music industry is filled with many diverse personalities who, in order to be as productive as they are in one field, must limit their growth in other fields. Very few engineers are also good musicians; very few musicians are also good producers; very few producers are also good at graphics and sales promotion. . . . The commercial recording field is the sum of these people's abilities. However, as each group becomes more esoteric, it becomes harder for each to see the necessity for the other's skill. We've all heard of engineers who pick up a synthesizer as an "engineer's instrument" and find out that being a musician is harder than it looks. (What about being an engineer? —JW) But if that lack of vision shows

up when a commercial engineer speaks to a basement engineer, it's really unforgivable.

The question of the basement engineer is, "What do you do when the musician has a noisy, authentic amp and you want to record it?" The commercial engineer says, "The amp the musician wants to use is far less important than cranking out that record within a certain number of hours. Send him down to Guitar Center to get a new amp," and if Dr. John's interview (?—JW) is true, you crank out that album in six hours of recording time with studio musicians who have never rehearsed the music. Or maybe it's some jingle for a chewing gum commercial and using a quiet amp is far more important than tone quality since, after all, it's only coming out of a t.v. set anyway and somebody's going to be talking over it and you've got to get it done before you run into the next guy's appointment.

This is not the basement engineer's situation. He's recording a band that makes its living playing live gigs and just want to record because they're imagining how they would do it if they were making a record. The basement engineer is recording the equipment the band brings in, and they aren't going to buy a new amplifier

just to do recording. They use the one they use on stage where buzz, pop, radio stations and hum are covered by small talk, clinking glasses, and most of all, by the visual performance. The performer doesn't want to get a new amp because it takes time and practice to learn to use the non-linearities and resonances of any amplifier-instrument combination. The engineer's job is not to say, "No, you can't sound the way you want to." His job is to make a finished product to please both the musician who is paying for the recording time (that may be the biggest difference between commercial and basement recording) and the outside listener.

So, it's a legitimate question. "What do you do about a noisy amplifier?" You can narrow the bandpass quite a bit. You can ride gain during the mix, keeping the channel down when its not as important. It's a subjective thing—reducing an instrument by 6 dB when it's playing chords behind a melody does not alter its impact on a song a great deal, but will make a great difference in how much the listener is irritated by the noise. When the instrument has an active part in the music, the noise behind it can be much louder and still not be objectionable. You can use the Phil Spector technique of miking a bit more distant than is typical in today's recording. Noise is somehow less objectionable when it's not quite as direct to your ear. If you have the money, you can use an MXR noise gate or a Kepex unit to eliminate noise when there is no signal. Active filters like the Burwen work when broader bandpass is necessary. These are some workable suggestions.

Mr. Woram would perhaps be better off to save his remarks on professionalism and not waste time trying to salvage sound for his students who must deal with his patch bay, and Neve and RCA consoles which have every connector wired to a different standard. Doesn't sound too time saving, hum-free, or professional to me.

Hopefully, next time a letter comes in asking about the problems of a recording engineer, it can be handled without sarcasm, without reference to creativity or professionalism, and with some clear advice leading to a solution. This is what you as an editor can ensure.

signed, D.L.

To me, the first and last paragraph tell where reader D. L. is at. First he complains about the lack of information available for basement operation (a good point), then says he wants clear advice without reference to creativity or professionalism!! If

## NEW AUDIO SPECTRUM MONITOR!

### 1/3 OCTAVE REAL TIME ANALYSIS MODEL 142

#### FEATURES

- PEAK READING • TWO MEMORIES: CUMULATIVE OR SAMPLE • VARIABLE TIME CONSTANTS (0.1 - 2 SEC.) • CALIBRATED IN DBM • 10-20-30 DB DISPLAY RANGE • 40 HZ to 16 KHZ ON 1/3 OCTAVE ISO CENTERS • 11 x 28 LED ARRAY • BUILT-IN PINK NOISE SOURCE • 3 1/2" x 8" DEEP RACK MOUNT.

#### USES

- PROGRAM MATERIAL MONITORING • RECORDING AND MIX-DOWN ANALYSIS • PORTABLE SYSTEM ADJUSTMENT • TAPE EQUALIZATION AND CALIBRATION • TRANSMISSION LINE EQUALIZATION • BEFORE-AFTER COMPARISONS • FREQUENCY RESPONSE TESTING



Suggested  
List Price \$3200

ALSO: Active and passive equalizers • Other real time analyzers  
Dealer inquiries invited

**White**

Call or write today: WHITE INSTRUMENTS, INC.  
P.O. BOX 698 512/892-0752 Austin, Texas 78767

Circle 17 on Reader Service Card

www.americanradiohistory.com



## Fully professional Studer quality at affordable prices

The new generation of professional STUDER tape recorders is designed for the use in broadcasting, television and recording studios as well as theatres and scientific laboratories. The low-cost STUDER A67 includes a wide range of modern features:

3 servo controlled AC motors – Crystal controlled capstan servo – Variable tape speed (2½" . . . 22½") with external frequency – Tape tension control during all operating modes – Control logic with memory – Illuminated push buttons – Remote control of all tape transport operating modes – Automatics for continuous program – Mechanical counter, indicating Min & Sec – AC-Mains supply 50 or 60 Hz, 110 . . . 250 Volts – Opto electronic end of tape sensor – Head block with aluminium die-cast frame –

Tape lifter, may also be operated manually – Long life heads – Audio electronics module with plug-in cards in front of tape deck – Playback, record and bias amplifier boards have all necessary adjustments accessible from the front of the recorder – Switchable for equalization CCIR or NAB – Optional: VU-Meter/panel with peak indication (LED) – Head phone jacks – Available with or without VU-panel, as portable or console version or as chassis for 19" rack mounting – ½-inch, 4 track version in preparation.

### STUDER

WILLI STUDER AMERICA, INC.  
1819 Broadway, Nashville, TN. 37203  
In Canada: STUDER REVOX CANADA, LTD.  
14 Banigan Dr., Toronto, Ontario M4H 1E9

# Trouper Series



## The Trouper Series — Permanent Yet Portable

You're looking for a live music mixer to fit your budget, yet performs like a million bucks. It's got to meet your specifications but you don't have a fortune to spend. Look at the Trouper Series. You can start small and add on at any time. We've got a wide variety of expandable mixers, and a complete selection of accessory packages, direct boxes, mic splitters and more. Our equipment bolts and plugs together making it the most flexible, and completely customizable mixing system available today. So whether you've got a fortune to spend or not, check out the Trouper Series — We've got a sound for you. Write for catalog.



DESIGNERS & MANUFACTURERS OF PROFESSIONAL AUDIO SYSTEMS & EQUIPMENT  
5559 CAHUENGA BLVD., NORTH HOLLYWOOD, CALIFORNIA 91601 / (213) 985-9501

Circle 25 on Reader Service Card

# SOUND INVESTMENTS

## PAYING BIG DIVIDENDS TO THE PROFESSIONAL

**YOU CAN'T AFFORD TO SOUND BAD.** You need the very best equipment available to do justice to your own special kind of sound. Our technicians know the best way to bring your true sound to audiences in the various auditoriums, theaters, clubs, indoor and outdoor arenas. Our staff members have played in many of these situations and so can guide you in the selection of the correct audio systems to convey a true rendition of your particular sound regardless of the halls or stages you will play. Does that sound like a pretty big statement? Drop in and see how well we can back it up!



If you can't stop into our showroom...  
Send for a FREE BROCHURE:

**Quantum Audio, Inc.**

200 Park Ave. So., New York, N. Y. 10003  
Tel.: 212-260-2300

Demonstration equipment of all major sound system manufacturers on display in a working environment with expert audio consultants.

**See us at Booth 4**

We stock Altec Pro, Community Light & Sound, Crown, Emilar, Gauss, JBL Pro, BGW, Malatchi, 2005 AD, SAE, Shure SR, Yamaha, Audio Fabricators.  
Exclusive U.S. Distributor of Gelf; and other famous audio equipment.

We maintain a large stock of replacement diaphragms for Altec, Gauss, and JBL Professional Products.

Circle 27 on Reader Service Card

www.americanradiohistory.com

## the sync track (cont.)

you really mean that, D.L., you're wasting your time reading *db*. Or any other magazine for that matter. Forgive my sarcasm, but why not get yourself a little sign that says "Certified Recording Engineer" and save yourself a lot of time and trouble.

Your impression of the commercial engineer is intriguing, to say the least. But it should be no secret by now that the engineer does not call the shots on most sessions. He is being paid by the client (directly or indirectly) and his first task is to please that client. In the unlikely event that he sends you down to Guitar Center to get a new amp, it is because he has been told to do so by the man in charge. Chances are, he would prefer spending more time helping you to get a better sound, but the money people are pulling him the other way.

And what if it is "some jingle for a chewing gum commercial and using a quiet amp is far more important than tone quality . . ."? If you say a quiet amp is far more important, then why on earth not use one? And if you need more time than you book, next time try booking more time than you need, so you don't wind up ruining someone else's session just because you can't get your own together? In other words, if you pay for three hours of time, don't try to rip the studio off for six. It's possible that the next guy is anxious to do his thing too.

As for the basement engineer, you find him working with musicians who are unwilling or unable to put in "time and practice to learn." What a depressing world you live in! Your engineer is doomed to please these clods as well as the outside listener. How the hell is he supposed to pull that off? You suggest MXR noise gates. Kepex's. and Burwen filters. Wake up, D.L.! These marvelous gadgets are supposed to be used creatively. But if you put no talent in, you get no talent out.

Personally, I think you've got a pretty poor impression of most basement engineers. I've met a lot of them at the Institute of Audio Research, and most are anxious to put in even more time and practice learning their craft. That's why the consoles at the school are left the way they are. The student *has* to understand what he's doing, or the equipment won't work. It gets confusing at times but most of them manage to survive, and when they return to their basement studios, they may be in better shape to help you and your musician friends. That is, if you'd listen. ■



# How we got our great reputation without advertising.

Until now, we haven't had the nerve to advertise our 16 into 2 mixer.

To be honest, we've found its popularity embarrassing.

People love its reliability, and the way it does everything they want without costing the earth.

And they've been buying so many that we've scarcely been able to keep up with the orders.

Fortunately, we've grown a lot recently. We're big enough to keep ahead of orders, which means that at long last we can supply them from stock.

So we've decided to live dangerously and start advertising.

Soundcraft Electronics Ltd  
5-8 Gt Sutton Street  
London EC1V 0BX England  
Tel 01-251 3631  
Grams Soundcraft LDN EC1

ADVERTISEMENT



Specifications:  
Mic input 200  $\Omega$ .  
Input attenuation infinitely variable.  
Max gain 70dB.  
4-band equalisation 60, 250, 3k, 15kHz.  
Channel switching off/on/prefade listen.  
Foldback, echo and pan on each channel.  
Input noise - 125dBm.  
Total harmonic distortion < 0.1% @ 1kHz.  
Crosstalk better than 65dB.  
Max output level +20dBm ( $\approx$  8v rms).

Output control:  
2-band equalisation on foldback and masters.  
Left and right master, and foldback faders.

Echo control:  
2 mixed inputs  
4-band equalisation  
Echo to foldback  
Pan and channel switching

Monitoring:  
Two 5" VU meters switchable to display master, foldback or prefade.  
200  $\Omega$  headphone output similarly switchable.

It comes built into a Cripple Creek flight case, and there is an optional multicore and stage box.  
A 12 into 2 version is also available.  
Write to Soundcraft direct for full literature package.

**SOUNDCRAFT**  
ELECTRONICS LIMITED

## REMOTE BROADCASTING



### REMOTE SITE CONSOLE

- Use Standard Telephone Line
- Direct Distance Dialing
- Set Up and Check Out in Minutes
- High and Low End Frequency Compensation with Automatic Level Control Option
- Lost Line Auto Hang Up Option
- Auto Pick Up on Redial Option
- Up to Six Microphone Inputs With Level Control Option. Four Headphone Outputs With Level Control
- Output Matched For Standard Telephone Line or Loop With Level Control. VU Meter. Built In Telephone Line Coupler and Output For PA Amplifier
- AC/DC With Battery Test Meter
- Built In Telephone Dial
- Options In Addition to Those Noted Include: Carrying Case. Microphones. Headsets. Test Tone Generator. Aux Inputs. Phono Cartridge Input and Three Pin Connectors



### STATION END CONSOLE

PULSE DYNAMICS MANUFACTURING CORP.  
Box 355, Depot St., Colchester Ill. 62326  
309-776-4111



Circle 28 on Reader Service Card

# Recording Booth Maintenance

• Many broadcast stations install a recording booth that is independent of the main control room. There are many advantages in having a separate recording booth—it soon becomes the workhorse site for all commercial and public service announcement production, as well as other program materials recorded for later play over the station's regular facilities.

Because the recorded tape product of the booth will make a large contribution to the station's air programming, the technical quality of this product should be at least equal to that produced by the regular station equipment. This fact should be borne in mind when selecting the original booth equipment. And although the booth equipment may not be the same models or even the same size as the units in the regular station equipment, the output quality should be equal. Even though during the original installation, all the booth equipment was fine-tuned to quality criteria, it will not stay that way. Any equipment that sees heavy usage will begin to wear and lose adjustment; tape machines become clogged with debris or residue from the tape. A regular maintenance program, keeping equipment in tip top condition, should be carried on as regularly as the servicing of the station's regular equipment.

Maintenance procedures should be scheduled at regular intervals. If not they become haphazard. How often the individual procedures are scheduled depends upon the usage of the booth and the station's own routines. The important thing is that they are regularly scheduled.

## CLEANING

At least once a week, all the tape machines should have a thorough cleaning. Clean the heads, pressure rollers, guides and any tape contact

surface. This schedule depends upon usage and the equipment itself. Cartridge tape equipment requires more cleaning than open-reel machines because of the special lubricant on the tape. Even with a weekly cleaning schedule, announcers should check the heads and, if necessary, at least clean the heads before a long recording session.

## LEVEL SETTING

Normal recording levels, and the playback levels of the master recorder should be tested on a regular basis. At the same time, the playback level of the various source machines and turntables are checked. This can be done about once a month. Use the standard level-setting tapes that were made during the initial installation of the booth. By checking standard levels on a regular basis, slow deterioration of the system can be detected. At the same time, it can also show up the fact that some knob twiddler has been active.

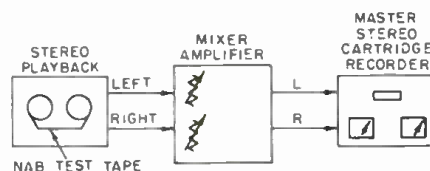
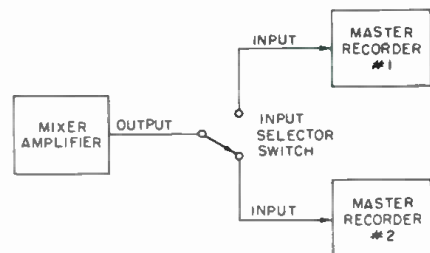

Figure 1. Run the NAB test tape on a source machine and then dub it onto a tape in the master recorder.

Figure 2. Carelessness can end up with blank tape if the input selector to the recorder is not in the correct position.



## 32 Page Lab Report

The most definitive and comprehensive test report ever conducted on high powered audio amplifiers—reprinted from the prestigious English journal, *Hi-Fi For Pleasure*. The spiral bound, hard-cover report presents readable research data taken from exhaustive subjective listening panel evaluations corroborated by standard laboratory tests. Some of the products reviewed in this Spring '76 report:

- Accuphase P250 • Crown D150A
- BGW Model 250 • Lux M6000
- Yamaha B1

Mailed first class upon receipt of two dollars and your full address.  
Amplifier Reports, P.O. Box 3742, Dept. DB  
Beverly Hills, Ca., 90212

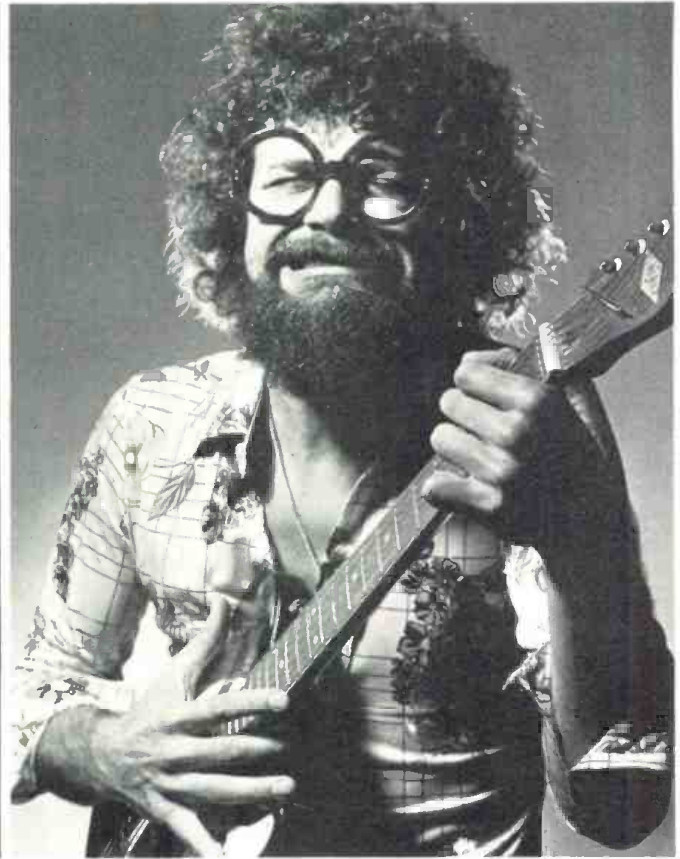
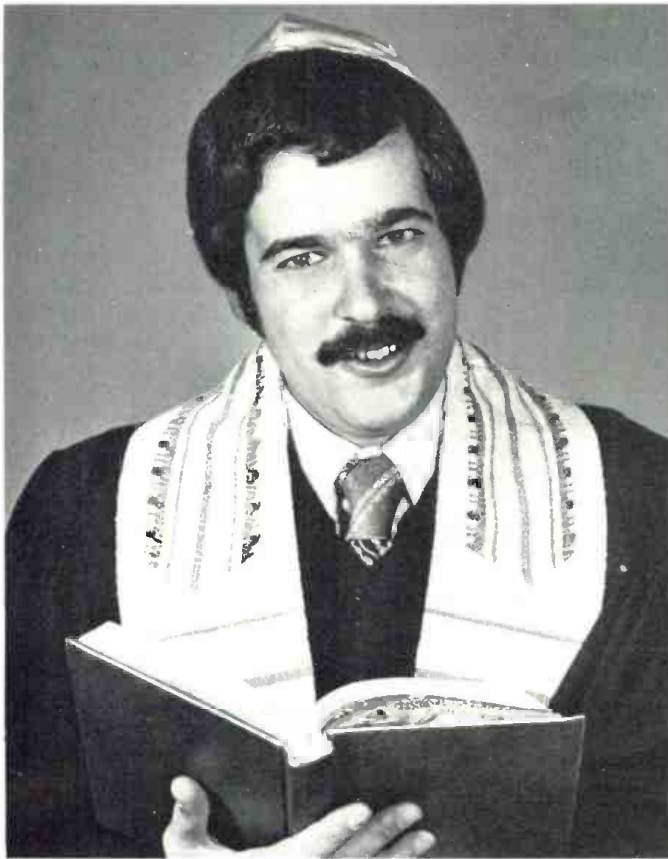

## What do the Rabbi and Rock Singer have in common?

Both have their message. And they both need good sound systems to get their messages heard by large groups of followers. We've got something that helps do that a quantum better.

### Electro-Voice Line Radiator™ speakers put out better sound.

The big difference between our LR4B and LR7B and any previous column speakers is in how good the Line Radiators sound.

For the first time, a column-type speaker configuration can convey all the inflections and effects of an accomplished orator, easily—and respond with like accuracy to the performance of the professional musician.

Soundmen who have listened to our LR4B and LR7B say they sound amazingly like our Sentry III and Sentry IVA: high accuracy designs for studio monitoring and sound reinforcement.

### The reason they sound like the highest quality speakers:

We have actually equipped our LR4B and LR7B Line Radiators with a Sentry component. To take over above 3500 Hz, where cone speakers become

too directional, we have built in our Sentry IVA tweeter. It has even, 120° horizontal dispersion.

To provide extraordinarily smooth frequency response from the rated low frequency limit to crossover, the Sentry tweeter is combined with six cone speakers optimized for performance below 3500 Hz, and a special crossover.

### What happens to the elegant parts when they're hit with high watts?

As in the Sentry IVA, the tweeter in the Line Radiators is permanently protected by our built-in STR tweeter protector. The cone speaker array is designed for long-term average inputs of up to 90 watts. Cloth surrounds provide long-excursion capability. High-temperature voice coils resist thermal damage.

### They're straight when you install them, curved when you hear them.

We use a unique multi-face construction (something like putting a curved Line Radiator inside a straight one). The shape is great for installation. The configuration provides accurately controlled, wide horizontal dispersion and narrow vertical dispersion while minimizing undesirable side lobes.

### Submerged, baked, tortured.

The quality control tests required for our Line Radiators include this dilly for the cone speakers: the speaker is plunged into water for 45 minutes, then baked for 8 hours at 180°F. That's done twice. After that, the speaker must work to spec with no rubs or buzzes.

Specifications	LR4B	LR7B
Response (±5 dB)	110-15,000 Hz	75-15,000 Hz
SPL, Full Power In at 4 feet	115 dB	115 dB
Long-Term Avg. Power Handling Capacity, Shaped Random Noise	90 watts	90 watts
Nominal Impedance	8 ohms	8 ohms
Dispersion, Avg. 500-8000 Hz Octave Bands	120° Hor. 60° Vert.	120° Hor. 60° Vert.
Dimensions	48" (122 cm) H 9 3/4" (24.8 cm) W 7 1/2" (19 cm) D	62.2" (158 cm) H 12" (30.5 cm) W 12" (30.5 cm) D
Net Weight	40 lb. (18.14 kg) \$270.00	62 lb. (28.12 kg) \$333.00
Suggested Retail Net Price (Slightly higher in Western States).		



LR4B



LR7B

**Electro-Voice**<sup>®</sup>  
INC  
a gulton company

Dept 1066BD  
686 Cecil St.  
Buchanan, Michigan 49107

Circle 21 on Reader Service Card

www.americanradiohistory.com

## A FULL LINE DISTRIBUTOR Reel-to-Reel Tape and Cassettes

Maxell • Capitol  
3M • TDK • Ampex

- Lube & Cassette Tape
- Lacquer Disc
- Batteries
- Reels & Boxes
- Video Tape & Cassettes
- Broadcast Cartridges  
Capitol A-2  
Fidelipac
- Magnetic Film  
16 Full Coat  
35 Full Coat  
35 Striped
- Magnetic Film Leader
- Digital & Word  
Processing Cassettes—  
Floppy Disks

### Tara Audio Sales Ltd.

1370 Avenue of the Americas  
New York, N.Y. 10019 • 212-581-6950

Circle 47 on Reader Service Card

## Come Play With Us



### Tape Reproduce Amplifier

Self-contained, dual channel reproduce-only tape electronics package for professional applications demanding uncompromising performance and reliability. Accommodates virtually any tape or film reproduce head. Low noise design, 3-speed equalization, and phase compensation adjustment.

Model 376, \$550



1630 Dell Avenue, Campbell,  
CA 95008 (408) 374-8300

Circle 49 on Reader Service Card

## broadcast sound (cont.)

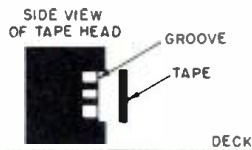

Figure 3. Much usage will wear down the head and form a groove.

At least once every six months, make a complete set of measurements on the booth equipment, including response, distortion, noise, cross-talk, turntable rumble, etc. You might call this a proof-of-performance as is done on the main station annually. These checks will show up overall deterioration of all the equipment—the tests should be run on all the equipment as a system, rather than on individual units on the bench.

Use the NAB standard test tape on a source tape machine and your distortion analyzer on the output of the mixer amplifier. Make sure the amplifier is properly terminated in the correct impedance. For the turntables, use a standard NAB test record. Check each of the units through the mixer output and make notations of the results. Next, set up a standard test tape on the main source machine and run this through the mixer, but this time, *dub* it onto the master recorder. This is a more severe test, but it will show up the master recorder in its usual setup, for that is what is going on when tape dubs are made.

Since there are many tests to run, they can be spread out over one or two weeks if necessary. A booth that is normally busy will not have too much free time anyway.

Even with a regular maintenance program, day-to-day problems will occur as they do with the regular equipment. These generally fall into two classes: operational errors and equipment problems.

The station will receive many tapes from outside sources that are to be

Figure 4. Leads can be placed incorrectly on the recording head and cause phasing problems in stereo recorders.

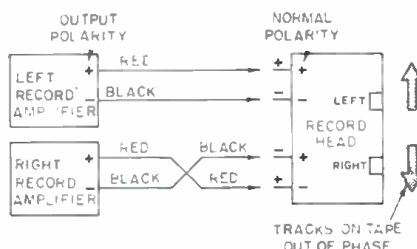

dubbed in part or entirely onto station tapes. Tapes received from commercial recording studios will normally be good quality, but those from private sources are not always satisfactory. Unfortunately, many of these are from advertising accounts, such as new car dealers, who want to make the tapes themselves. They use a small, cheap recorder, and it takes a magician in the recording booth to dub these with only the barest acceptable air quality. Even then, some are much less than air quality, but the sponsor wants to use them anyway.

When the announcer must work with such a tape, he can use all the production techniques, production equalizers etc. that are available, but he *should not* twiddle the basic adjustments of the tape heads or equalizers. If he does, it will be necessary to go back and re-align those machines; otherwise the general quality will suffer.

### AUTOMATION WON'T WORK

The usual problems are cartridge tapes that play with very low program levels, won't switch the automation, or the tape won't stop. All of these could be caused by problems with the particular machine or tray in the automation, but the culprit can also be a poor recording. The quickest check is to play a tape known to be good in that place in the automation, and if it plays okay, then you know the troublesome tape is bad. Check the tape out in the master recorder, but first, inspect the cartridge itself. Look for defective pressure pads, bad tape or parts out of place. In most cases, the trouble will be in the cartridge, but it could be oxide buildup on the recorder heads or guides that do not allow the cartridge to seat. This type of problem is really caused by human error, for the announcer should have inspected the cartridge before use, and then auditioned it after it was recorded.

### BLANK TAPE

An operational error can happen when there is more than one master recorder and the output of the mixer must be switched to the correct recorder input. If the announcer becomes careless and doesn't make the normal checks to make sure that he is set up to record on the correct machine, the switch may be in the wrong position. He goes ahead and does the recording, and then without auditioning the tape, plugs it into the automation. A short while later it is called for on the air—Carelessness, sure, but it does happen and often.

### TAPE HEADS

When the oxide on the tape wears

# WKLS, Atlanta, broadcasts 100% disc-to-air. That's why it uses Stanton's 681 series... exclusively.



Bob Helbush, Chief Engineer, making a quality control check using a 681 cartridge.

Top notch broadcasters who capture a large share of the listening audience, are critically aware of the necessity to achieve a superior quality of sound. Station WKLS is just such a station.

As Bob Helbush, chief engineer, states: "We broadcast 100% disc-to-air except for some commercials. So, for maximum quality sound and phase stability, we use the Stanton 681 SE for on-the-air use. We consider it the ideal answer for that application. And our program director uses Stanton's 681 Triple-E for auditing new releases before we air them".

And Don Waterman, General Manager, added: "Today, every station in the SJR Communications group . . . all eight of them, all in Major Markets . . . use Stanton 681 cartridges on every turntable".

There are good reasons for this vast acceptance. Stanton's 681 Calibration Series cartridges offer improved track-

ing at *all* frequencies. They achieve perfectly flat frequency response to beyond 20 Kc. And the top-of-the-line, superb 681 Triple-E has an ultra miniaturized stylus assembly with substantially less mass than previously, yet it possesses even greater durability than had been thought possible to achieve.

Each 681 Series cartridge is guaranteed to meet its specifications within exacting limits and each one boasts the most meaningful warranty. An individually calibrated test result is packed with each unit.

Whether your usage involves recording, broadcasting or home entertainment, your choice should be the choice of the professionals... the STANTON 681.

Write today for further information to Stanton Magnetics, Terminal Drive, Plainview, N.Y. 11803.



Circle 23 on Reader Service Card

# INTRODUCING A NEW AUDIO CONNECTOR

MODEL: PM-3

## FEATURES:



1. Gold contacts
2. Ground lug
3. Mounting holes designed for 1/8 pop-rivets
4. Special non-reflecting finish
5. Economical
6. Compatible w/XL's

## INTRODUCTORY PRICE OFFER\*

50	100	500	1M	10M
\$1.00	.82	.78	.74	.67

SOLD IN LOTS OF 50 ONLY

TERMS: 5% Discount Cash with order, or COD only, FOB Delivered



(800) 421-1828, (213) 770-3510  
TWX 910 346-7023  
P.O. Box 590 GARDENA, CA 90247

\* OFFER GOOD IN USA ONLY and EXPIRES JANUARY 31, 1977

Circle 19 on Reader Service Card

## broadcast sound (cont.)

down the head, the gap opens or widens, and tape-to-head contact of the tape begins to show up in poor and erratic quality in the recordings, the heads need replacing. If the machine is the master recorder, replacement and realignment require extra care. It is not enough to have a good response curve on that particular machine—the tape will also be played on other station machines and should be compatible.

Make the head replacement with the correct heads (same model numbers that were taken off) and get them into the same physical position as the old heads. Use the gauges and other devices available to just about put the head into alignment. But use a standard NAB test tape and electronically align the playback head first. Use this as a standard to align the record head. Tones fed to the record amplifier should be at least 10 dB below program level to avoid problems with the internal equalizers.

The tape with tones recorded during the alignment process on the recorder should be played on at least one of the main station playback machines and the results noted. Ordinarily, this will be within specs. If it is

not, the head on the recorder may not be correctly aligned. This can sometimes happen when the equalizers needed much adjustment and especially if the playback equalizer was adjusted by mistake instead of the recording equalizer. If the tape is not compatible, go back and do the alignment over.

## HEAD PHASING

On multi-track stereo recorders, it is easy to get the head leads mixed up and put on incorrectly so that one of the tracks is reversed polarity of the other track. This creates a phasing problem. Use special care in replacing the leads, and as a final check, play a recording made on the machine into an arrangement where the two channels are paralleled together into a monaural amplifier. If the two channels are out of phase, the signal will cancel and the monaural level will drop severely. This is the same thing the matrix does in the transmitter stereo generator to provide the compatible monaural signal, and the results you will get here are the same the monaural receiver will get.

## COMPRESSORS

The booth may use a compressor between the mixer and the recorder. This calls for careful setting of the various levels. Use a sine wave tone of equal amplitude on both inputs of the stereo unit (mixer) and adjust all the levels throughout to correct values on the tone. This includes the compressor and recorder. For the test, disconnect the tie connection between the left and right compressors, since you need to make the adjustments correctly to both units. But consider the tone set up as preliminary; the system can operate differently on program material. Next, use a monaural record or full track monaural tape to feed a monaural program over both channels. The monaural signal will feed both channels equally. Try to select a program number that has plenty of activity and somewhat regular peaks. Now set the adjustments against this and lock the controls. The master recorder controls should not be operational and should be locked, even if there is no compressor. Once set up, the console vu meter should be used for production level monitoring.

## SUMMARY

The recording booth is an important source of program material so its product's technical quality should be equal to that coming through the regular station equipment. But it won't stay that way unless a regular maintenance program is carried on and day-to-day problems corrected as they arise. ■



## A professional makes even the toughest jobs seem easy

That's the way it is with Waters professional audio attenuators. They feature glass-hard MystR® conductive plastic elements and slip rings as well as precious metal contacts. What's more, Waters' computer-controlled curve-shaping technique assures superior tracking.

Result: smooth, quiet, long-life performance under the most grueling service conditions.

You'll find Waters complete line of professional audio controls meets every need — linear or rotary motion — mono, stereo, or quad. Two standard impedance values are now available, 600 or 10,000 ohms.

If you're into mixing, you ought to get the complete story on Waters audio controls. Write today, or call us at 617-358-2777.

It's the professional way.



**WATERS  
MANUFACTURING, INC.**

Longfellow Center, Wayland, MA 01778 617-358-2777



Circle 55 on Reader Service Card

# The De-esser.

The Orban/Parasound 516EC Dynamic Sibilance Controller finds its way into more top recording and film studios every month—because it really works. Unlike compressors and limiters with afterthought “de-ess” functions, the 516EC doesn’t pump or breathe, and it’s not fooled by low-frequency energy. Unlike dynamic filters, it controls sibilance by reducing gain at all frequencies—so low-frequency intermodulation products which often accompany sibilance overloads are effectively reduced along with the sibilance itself. In addition, the threshold of the 516EC tracks the average input level, so de-essing is constant despite changes in input level of 15 dB or more.

With a 107 dB overload/noise ratio, and distortion typically below 0.1%, the 516EC is a fitting companion to state-of-the-art studio gear. And its ease of use simplifies a hassled mixer’s life: there’s only one adjustment necessary to determine the amount of action. A LED lights whenever de-essing is taking place, and the action can be defeated in the middle of a track without clicks or gain changes.

The \$595 Dynamic Sibilance Controller contains three independent channels to handle separate vocal mikes or magnetic dummies without interaction. A dual-primary power transformer puts it at home anywhere in the world while levels and impedances permit easy interfacing with any professional audio equipment.

516EC customers often wonder how they ever got along without it. And in today’s competitive studio market, the creative freedom offered by really effective de-essing yields a strong competitive edge. For further information on the 516EC Dynamic Sibilance Controller, see your local Orban/Parasound distributor, or contact:

**orban/parasound**

680 Beach Street  
San Francisco, Ca. 94109  
(415) 673-4554



Circle 12 on Reader Service Card



# The Sensible Alternative MX-7308

- Sensibly priced at \$8150 including console
- Compatible one-inch eight track format
- Motion sense logic to prevent tape damage
- Reel tension servo to improve start time
- Professional 600 ohm +4 or +8dBm outputs with XLR connectors
- Optional remote synchronous-reproduce on all channels
- 15/30 ips now available from stock (7 1/2/15 ips on special order).

**OTARI**

The only company with both one-inch and one-half inch eight track recorders

Otari Corporation  
981 Industrial Road, San Carlos, Calif. 94070  
(415) 593-1648 TWX: 910-376-4890  
In Canada: Noresco Mfg., Toronto (416) 249-7316  
MANUFACTURED BY OTARI ELECTRIC CO. TOKYO, JAPAN

Circle 24 on Reader Service Card

● In the last two columns, we discussed visiting the site of a meeting you were asked to set up, and the a/v equipment you might need for the presentation requirements. Now, the day of the presentation has arrived, and the time has come to set up and run the show. A couple of hints might prove helpful.

First, and foremost, set up as long before the show as possible, preferably the day before. This will not only allow you the ease and comfort of being able to run cables without haste, but also to check again each piece of equipment after the setup is completed. It also will permit you to call your office for replacement in the event you did forget something or one of the pieces does not work.

Getting to the site early can give you time to check with the house men who will be setting the tables and

chairs in place to be sure all will be placed where you planned during your preliminary visits. Trying to get people to move chairs or tables or platforms or the lectern or the dais table after they have received their "final" instructions can be a hair-raising experience. Try to forestall this problem by getting there in time to check things out before it all happens.

For the setup, the screen is in place, the projection table (or tables) in position, the projectors lined up, and the auxiliary speaker put in place. The video monitors are set up, the audio and video tape machines located properly, and now the cables have to be put down. You can either think of this part of the operation in terms of systems (audio, video, projection) or in terms of location (cables to the front down the middle, cables to each side) and a.c. lines.

#### CABLES

Once the cables are down, try the systems out before you hide the lengths. Be sure the sound is clean, the remote control for the slide projector works and has plenty of slack in case the presenter decides to walk around with the "pickle" in his hand, and that there is power to all the units. The cables should be hidden under carpets or they should be taped down. If they are run behind chairs along the wall, be sure they cannot be pulled apart by a chair or table being moved.

When cables are interconnected with extensions, a half-twist or tape will keep the connections from separating. Cables under carpets should be tucked in far enough so they don't come out easily when people walk over them. The edges of the carpets should be taped down to the floor or to adjacent carpeting. Large connec-

# You oughta have your head examined.

And your pinchwheel inspected.

And your clutch and brake checked.

In fact, if you depend on your Nagra for your living, a periodic check-up with Jerry Ozment (The Nagra Specialist) will bring every gear and gizmo under his scrutiny.

Jerry has lived and breathed Nagras for the past ten years as both a repair technician and motion picture sound man.

His ability to modify and adapt standard Nagras to specific needs for unusual situations is startling.

His repair skills have set a standard in professional circles.

And, of course, all modifications and repairs are fully guaranteed by Mobius Cine, Ltd., the home of the Nagra Specialist.

## The Nagra Specialist at Mobius Cine Ltd.

7 East 47th Street, New York, N.Y. 10017 212 758-3770

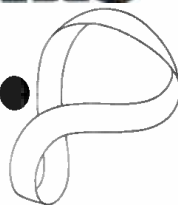

Circle 37 on Reader Service Card

www.americanradiohistory.com



tors should be taped also, with enough tape to prevent anyone from tripping over the connection and pulling the cables out in the open.

Don't use masking tape or scotch-type tape. Electrical tape isn't bad, but you'll find that it works well around the connection, and sometimes to keep the cable on the floor, but not stuck to the carpeting. Paper-based tape, either white or black, is good for some things, but it's not effective to keep carpeting stuck down or cables stuck to carpeting. Use gaffer tape. It really sticks. It is used in stage work, and can be employed just about anywhere for almost anything. Try using brightly colored tape, in any event, to alert people that the cable and tape, and connection are there. Better slightly unsightly and safe than to have someone trip, fall, get hurt, sue, and, worst of all, pull the connection apart.

#### DRESS REHEARSAL

With all the equipment checked out and working fine, and all the cables safely in place, you should have time to go over the presentation itself. Start with the slide projector, for example. It's lined up so that both the horizontal (and vertical, if any) slides fit on the screen with no keystoneing and the

slides in sharp focus. Now is the time to put a blank slide in the projector aperture so that you can change drums without turning off the lamp and without having a big white light on the screen.

When setting up the film projector, either start with a take-up reel big enough to hold the first film, and then get a second take-up reel ready for the second, etc., or begin with a large enough reel to hold all the films. In this latter case, you can use tape to tie the end of the first to the beginning of the second, and so on. If the film projector you are using is a manual loading type, you deserve two extra points, because the films can be put on the projector with a minimum of disturbance to the crowd.

If you have an auto-load type, each film has to be run through the projector till the leader at the start goes through and the first film frame is cued up. (The same is true at the end of each film with the leader having to run until you can get the next film on. The best way to avoid this, of course, is to have all films tied on one long reel with blank in between. Where the film is to run through several short pieces, a second-and-a-half of blank space is sufficient. Where you have to

stop the machine, three seconds might be right.) Double check that each time a film has to be shown between slides there is a blank slide in the drum. This avoids the need to turn off the slide projector lamp for each film.

#### AUDIO TAPE RECORDER

When considering the tape on the audio tape recorder, try to be sure that the reel has white leader between sections to permit tight cueing for each play. Otherwise, you can run each cut down and use white splicing tape (which you always carry in your "survival" kit) to mark, visibly, where each cut begins.

Regarding the video tape, if you have a player with a pause control, you are ahead in the start/stop department because you don't have the tape running back into the cassette each time. However, if there is a long slate-and-color bar run-down ahead of each spot, there is a problem. The same, although slightly less embarrassing, wait results each time you start the unit when there is a long black stretch between spots. Either the tape should be prepared without count-down or long black, or each start point should be located by index number on the machine.

## SESCOM'S CABLE TESTER

AVAILABLE IN STOCK FROM THESE PARTICIPATING DEALERS

### MODEL CT-1A "CABLE TESTER"



*Tests for opens, shorts, phasing and continuity. The CT-1A is pocket-sized, lightweight and battery powered. Tests Male to Female Cannons or stereo phone plugs. A very valuable tool for the field technician. Test cables before using them to avoid cable problems.*

PRO NET \$32.95



"Quality Engineered Sound Products"  
SESCOM, INC

P.O. BOX 590, Gardena CA 90247 U.S.A.  
(800) 421-1828 — (213) 770-3510

CA Gil Reyes Audio Concepts Inc. 7136 Santa Monica Blvd Hollywood, CA 90046 (213) 851-7172	CT Bob Dixon Fred Locke Pro Audio 62 Woodlawn Rd Berlin, CT 06037 (203) 828-1124	NJ Harry Stafford Tech Communications 1590 5th St Trenton, NJ 08638 (609) 695-4509
Jerry or Shelley Coast Recording Equip Supply 6114 Santa Monica Blvd Hollywood, CA 90038 (213) 462-6068	M. B. Faulkner AudioTechSales, Inc. 142 Hamilton Ave Stamford, CT 06902 (203) 359-2312	NY: Robert Manzo Harvey Radio Co 23 W. 45th St New York, NY 10036 (212) 575-5211
Jim Michaels Yale Radio Electric 6616 Sunset Blvd Hollywood, CA 90028 (213) 465-3186	IL Jerry Kollenberg Music Dealer Service 3210 N. Pulaski Chicago, IL 60641 (312) 282-8173	Frank Lannon Martin Audio 320 W. 46th St. New York, NY 10036 (212) 541-5900
Lew Levin RPS Electronics - Sound Foyer 1521 S. Hill St Los Angeles, CA 90015 (213) 747-7542	Dennis L. Starlek The Sound System 4348 W. 51 St Chicago, IL 60632 (312) 581-7436	Paul Ash Sam Ash Music Stores Throughout New York (212) 347-7757
Ken Hyams Allied Communications Inc. 875 N. Palm Canyon Dr Palm Springs, CA 92262 (714) 325-3028	MI Henry J. Root Hy James Enterprises 712 Catherine Ann Arbor, MI 48104 (313) 994-0834	Marc Pitt Comprehensive Service Corp. 18 West 51st St New York, NY 10023 (212) 586-6161
Robert Bucklong Zack Electronics 1644 Market St. San Francisco, CA 94102 (415) 626-1444	NC Lee Butler Coliseum Sound Systems 4427 Beryl Rd. Raleigh, NC 27606 (919) 821-2222	OH Stan Kozak Wintevatio Co 5373 Ridge Rd Parma, OH 44129 (216) 886-5536

CANADA  
Jim Bredon  
John R. Tilton Ltd  
1900A Eglinton Ave. East  
Scarborough, Ont. Canada  
(416) 757-4171

ENGLAND  
T. G. Blackham  
Future Film Developments  
90 Wardour St  
London, England W1V 3LE  
01-437-1852

If there is no dealer in your area, use the factory-direct toll-free number.

Circle 43 on Reader Service Card

www.americanradiohistory.com

# Communications Headsets... ...for whatever the job

Telex 1320 series headsets offers you six models for all general communications requirements, indoor or out. Single or dual dynamic drivers are impervious to environmental humidity or temperature changes. With optional boom mikes, noise canceling dynamic or carbon. Designed for comfort. Dependably made for heavy duty use. Complemented by the compact Telex IC-10, amplified common talk intercom system for dynamic mike headsets. For "whatever the job," please write for free information:



PRODUCTS OF SOUND RESEARCH

## TELEX

COMMUNICATIONS, INC.

9500 ALDRICH AVENUE SOUTH  
MINNEAPOLIS, MINN. 55420 U.S.A.  
Europe: 22, rue de la Légation - 92 Hammeur,  
92200 St. Denis, France  
Canada: Telex Electronics, Ltd., Scarborough, Ontario

A good way to cue up either audio or video tape is to use a pair of headphones to hear the first sound. But first be sure you have disconnected the feed from the audience system. You are probably already wise to cueing the audio tape. With the video, it takes about three or four digits before the starting number to cue up the  $\frac{3}{4}$  in. cassette on most players. With the  $\frac{1}{2}$  in. tape, starting from "pause" rather than "stop" will effect a smoother beginning.

### EMERGENCY EQUIPMENT

With all the films, tapes and slides ready to go, and all the equipment turned on and standing by, you're all set. So now, you can relax . . . and start thinking what to do in case something goes wrong. Spare lamps are at hand, spare take-up reels, scotch-like tape to "splice" film in case it splits during the showing, audio splicing tape, even extra audio take-up reels in case you have to switch audio reels and do not have the time to rewind the tape between plays—the same for  $\frac{1}{2}$  in. video tape.

You also start thinking what to do in the event the hot lamp on the slide projector has to come out with slides on top. Perhaps it would be easier to replace the whole projector unit instead—just take off the drum, put the other projector up, switch lenses or have an extra one in the new projector, and put the drum back to the proper number.

### WORK QUIETLY

Once the show is under way, you should try to work as quietly as possible. Replace film and reels, rewind tape, change cassettes, change slide drums, and so on, with a minimum of time between and with as little disturbance as possible. Try to work out the setup so that the show moves smoothly, professionally. Watch the drum to be sure when the last slide is coming up. Check the cueing of film and tape.

Make the presenter feel comfortable, confident that his a/v person is a competent professional doing everything to make the difficult chore of presenting a lot easier. When the show is over, turn off the slide projector which makes quite a noise while running in the fan position (unless, of course, you were smart enough to take the most quiet unit in the shop and it is one of the latest extra-quiet models.)

Don't rewind tape so the audience can hear it on the speaker. Don't try to rewind film if the meeting is still going on after the last of the audio-visual materials have been used. Leave the film tails-out, if necessary. It can

always be rewound later or back at the office. Wait to rewind audio or video tape, since the noise can be disturbing. Don't start moving or packing slide drums.

Leave the video cassette machine on until you have turned off the receiver/monitor. Otherwise, there will be a snowy screen and a hissing sound on the t.v. speaker. Leave the cables to be picked up after the audience has left so you don't run into them or trip them as they leave. A lot of things have to be done to pack your equipment, but wait so you don't louse up their meeting after you took so much pain to make it go so well. It takes as much professionalism to sit and wait (although impatiently) after your portion of the show is over, as it does to do the great job you just accomplished.

In the last three columns I've given you some hints on how to go about setting up an a./v. presentation. Preparation thinking is as important as the setup itself, and running the show. Emerson once said that skill to do comes of doing, and Voltaire said that common sense is not so common. Combine them and you become a professional a./v. specialist! Use your experience, learn from mistakes, and trust your common sense. And keep your mind alert. It's true that minds are like parachutes—they work only when open.

**CORRECTION:** On p. 31 of the July, 1976 issue, I made the statement, speaking of Motiva, Ltd., that their optical matrix slide registration method permits up to 49 images to be developed from a single 35 mm. slide. I have been informed that up to 121 images can be so developed. Sorry, Motiva! ■

### MOVING?

Keep **db** coming  
without interruption!

Send in your  
new address *promptly*.

Enclose your old  
**db** mailing label, too.

Write to:

Eloise Beach, *Circ. Mgr.*  
**db** Magazine  
1120 Old Country Rd.  
Plainview, N.Y. 11803

# db new products & services

## LOUDSPEAKER WATTMETER



• Solid state wattmeter model APM 176 is suited for producing the frequency vs. power delivered signature of loudspeakers and audio systems. It handles 4 to 16 ohm loads, measures audio and ultrasonic power at full scale values from 3 to 300 watts in 5 ranges, plus a zero to 10 dB reference scale. 20 to 20,000 Hz less than 0.1 dB; 100 kHz, less than 1 dB; useable to 200 kHz. The analog output (recorder) jacks provide zero to +1 volt output for zero to full scale, all ranges. Accuracy and linearity are claimed to be within 0.5 per cent.

Mfr: Electronic Wattmeter Co.

Price: \$349.00.

Circle 74 on Reader Service Card

## DRIFT AND FLUTTER METER



• Model 15P drift and flutter meter reads subjective peak flutter at ranges of 0.1 per cent and 0.5 per cent full scale with a claimed accuracy within 3 per cent of full scale. Drift measurement indicates the percentage of deviation relative to a stable internal oscillator with a range of  $\pm 5$  per cent and a claimed accuracy within 1 per cent. The internal oscillator, at 3,150 Hz, has a stability claimed at better than  $\pm 0.1$  per cent, with an output level of 1V rms and impedance of 25 ohms. The device will track carrier frequency of 2 kHz-4kHz at an impedance of 300,000 ohms.

Mfr: Xedit Corp.

Price: \$270 (with 'scope output: \$320)

Circle 75 on Reader Service Card

## SPEAKER PROTECTION FUSE

• This manufacturer now offers a fuse kit known as the F-Z Kit, which includes a five year guarantee extension for their speaker products. F-Z protects the following models from prolonged overload of power in excess of the maximum rated power: FRM-1, FRM-2, FRM-3 and MS-1. The kits contains fusing assemblies for two speakers, which are easily attached to the speakers without using tools.

Mfr: Micro-Acoustics Corp.

Price: \$10.00.

Circle 76 on Reader Service Card



# QUICK.

# HOW MUCH DOES A NEUMANN KM 84 COST?

# WRONG.

It's only \$230.

And that's for traditional NEUMANN quality! It's also true for the KM 83 omni-directional and the KM 85 cardioid with built-in low frequency roll-off. The KM 84 and KM 85 feature the NEUMANN "linear admittance" cardioid capsules which maintain linear frequency response even for a sound source as much as 135 degrees off axis. This means that unavoidable leakage from off-mike instruments, while properly attenuated, will remain natural sounding, without that typical low-end boost and high-end roll-off. For extra flexibility the 83, 84 and 85 screw-on capsules are available separately.

So, remember: you never go wrong with NEUMANN. And now, even the price is right: KM 83, 84 or 85, just \$230 complete with swivel, pop screen, and a case.

For more information write

**GOTHAM**  
AUDIO CORPORATION

Headquarters 741 Washington Street New York, NY 10014

(212) 741-7411

West Coast Sales Office 1710 N. LaBrea Ave Hollywood, CA 90046

(213) 874-4444



Circle 61 on Reader Service Card

## Cameraman's Headset... Keeps the crew in touch

A professional TV Cameraman's Headset series specifically designed to interface with existing Western Electric circuits. Single side unit receives intercom only. Dual side, binaural unit receives intercom and monitors program. Carbon boom mike with optional push-to-talk switch. Designed for comfort and rugged dependability in every day use. Keeps the crew in touch—in or out of the studio. For complete information please write:



PRODUCTS OF SOUND RESEARCH  
**TELEX**  
 COMMUNICATIONS, INC.  
 9600 ALDRICH AVENUE SOUTH  
 MINNEAPOLIS, MINN. 55425 U.S.A.  
 Europe: 72, rue de la Legion-d'Honneur,  
 92001 St. Denis, France  
 Canada: Telex Electronics Ltd., Scarborough, Ontario

Circle 57 on Reader Service Card

## products & services (cont.)

### BOOKSHELF SPEAKERS



● Designed by mathematical synthesis to yield a maximally flat response, characteristic of a quasi third order Butterworth filter, D2 three-way speaker is claimed to produce an output that is completely flat throughout its assigned frequency range. The system is vented, and the response decays asymptotically at the rate of 18 dB/octave below 37 Hz. The 10 in. woofer has a 1½ in. voice coil and 2-pound ferrite magnet. The 2 in. tweeter has a 5/8 in. voice coil and 3 oz. ferrite magnet. The crossover network is designed to slope gently in order to preserve amplitude and phase relationships.

Mfr: Ohm Acoustics Corp.

Circle 77 on Reader Service Card

### MINIATURE MIXER/PREAMP



● Miniaturized two-channel mixer/preamp, the battery-powered Gimp, provides two separate channels of mic or instrument pickup preamplification with a level control for each. Tiny enough to be carried in a pocket, Gimp can be used with any mic or instrument pickup having unbalanced line output, will drive up to 500 feet of line without high frequency loss or noise buildup, delivering 30 dB of gain. It will handle up to three sources, and will drive any tape recorder, equalizer, noise reduction system, or other line level device. The device accepts standard phone plug inputs.

Mfr: Rusound

Price: \$69.95.

Circle 78 on Reader Service Card

### DIGITAL MULTIMETER



● Hand-held digital multimeter model 21 measures capacitance along with a.c. volts, d.c. volts, and resistance. The palm-sized instrument has four d.c. voltage ranges with 1mV resolution; four a.c. voltage ranges with 1mV resolution; four resistance ranges with 1 ohm resolution; and four capacitance ranges with 1pFd resolution. The unit features 0.27 in. led displays, 3½ digit readout, and simplified five step calibration. Battery operated.

Mfr: Data Tech

Price \$189.00.

Circle 79 on Reader Service Card

### EIGHT-TRACK CONSOLE



Twelve inputs and eight outputs, as well as an 8 x 2 control room monitor mix and an 8 x 1 musicians' cue mix are featured on Model 1280 8-track recording console. The unit also has an independent 2-track mixdown bus. Each of the 12 inputs features 3-band equalization, a 35 dB trim control, 8-track pushbutton track assign matrix, full panning, echo send bus, mute and solo functions, 26 dB mic pad, mic/line switching, straight line faders, and pre- and post-fader patch points. There are led readouts for monitoring all output busses even while recording 8 tracks simultaneously. The console uses transformerless low Z mic preamps, with optional transformer-balanced inputs, employing gapless lamination transformers. Dual echo returns allow full panning and e.q. on the chamber returns; full slate and talkback functions are provided, using all f.e.t. switching.

Mfr: Sound Workshop

Price: \$2,850.

Circle 80 on Reader Service Card

## STEREO CARTRIDGE



- The ability to track at  $\frac{3}{4}$  to  $1\frac{1}{2}$  grams combined with ruggedness is claimed for 680EE stereo cartridge. The manufacturer developed the 680EE as an outgrowth of their tough disco model for those applications where critical listening is of more importance than super-toughness.

Mfr: Stanton Magnetics

Circle 81 on Reader Service Card

## MASTERING UNIT



- Known simply as "The Lathe," this high quality precision unit has feed and depth systems which utilize a proven sample-and-hold approach to generate multiple bit, digital information as to the frequency and level content of the program material. This allows minute changes in pitch and depth to occur many times a revolution. The device also offers a digital L.P.I. readout, 150X Nikon microscope with vertical illuminator, quick change cutter head mount and saddle designed to accommodate both Westrex and Ortofon cutter heads, and  $16\frac{2}{3}$  rpm turntable speed for CD-4 cutting. The Lathe includes a complete disc playback/calibration system and a computer designed isolation that eliminates external rumble. All functions are fully automated.

Mfr: L. J. Scully Mfg. Corp.

Price: \$42,000.

Circle 82 on Reader Service Card

# Assign Your Plotting to Our Top Draw-er.

It's an automatic audio frequency response plotter with features, accuracy, resolution and dollar value previously unobtainable (under \$2500.00!) We took a basic Hewlett-Packard X-Y plotter and modified it to accept UREI audio analysis plug-in modules. The standard Model 200 shown below includes a Model 2000 plug-in, making it an automatic sweep frequency generator and receiver, featuring Slope Sense\*, which insures that steep amplitude excursions will be accurately traced without the use of very slow sweep rates. The Slope Sense circuit automatically slows the sweep rate when rapid amplitude changes are encountered, and then resumes normal rate. The Model 200/2000 makes 20 Hz to 20 kHz response plots with 0.05 dB resolution and a dynamic range of over 60 dB on standard 3 cycle semi-log paper, K&E audio paper or DIN standard paper. Vertical scaling is changeable from centimeters to inches from the front panel. A number of accessory plug-in modules are currently being developed which will expand the Model 200's capability to plot other audio parameters. (UREI and Hewlett-Packard quality of course.) Available from your UREI dealer.

\*patent applied for.

**UREI**  
QUALITY  
OF COURSE

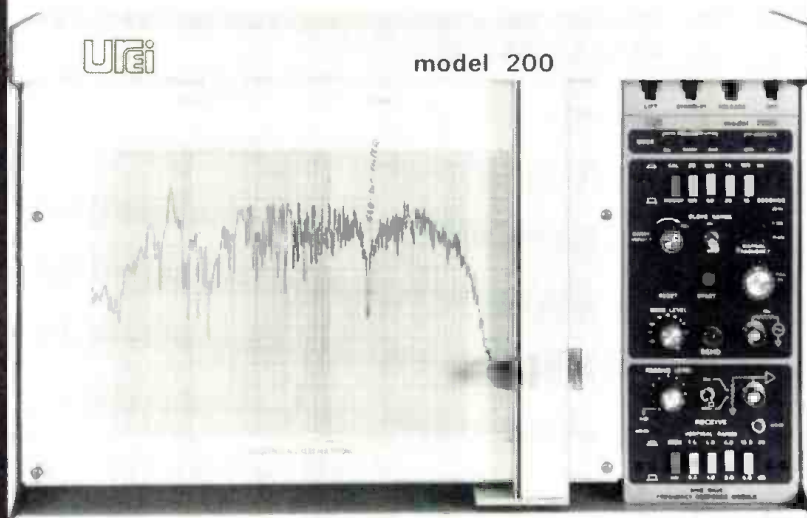

11922 Valerio Street No. Hollywood, California 91605 (213) 764-1500

Exclusive export agent: Gotham Export Corporation, New York

Circle 58 on Reader Service Card

## Sportscaster Headset... Color, Action, Hands-free Mobility

Combine the finest omnidirectional dynamic boom mike with an equally high performance bin-aural headphone and you have the superior Sportscaster headset...the Telex CS-90. For live broadcasts, from the station or on remotes, with cue and program monitoring and hands-free convenience. The audience hears every word, clearly, crisply, with crowd noise for background color and atmosphere. Circumaural ear cushions screen out noise in the immediate area so that special acoustic facilities are unnecessary. Supplied with convenient in-line, mike-muting "push-to-cough" switch. The Sportscaster headset. Color, action and hands-free mobility. For complete information please write:



PRODUCTS OF SOUND RESEARCH  
**TELEX**

COMMUNICATIONS, INC.  
9920 ALDRICH AVENUE SOUTH  
MINNEAPOLIS, MINN. 55425 U.S.A.  
Europe: 22, rue de la Lésion - 91000 Evry  
10710 St. Denis, France  
Canada: Telex Electronics, Ltd., Scarborough, Ontario

Circle 56 on Reader Service Card

## products & services (cont.)

### STEREO/MONO AMPLIFIER

● Designed for use in bi- and tri-amplified systems as a tweeter or horn driver amplifier, Model 100 stereo/mono power amplifier can also be used for driving electrostatic or conventional headphones. The unit offers clipping indicators, simple mono/stereo switching capabilities, Cannon style input connectors, and 8-pin octal type connectors for input matching transformers. Each led clipping light is driven by a 3-transistor one-shot circuit which lights the led for a flash whenever the amplifier is clipped.

*Mfr: BGW Systems*

*Price: With standard 1/4" jacks: \$319;  
with Cannon: \$339.*

*Circle 83 on Reader Service Card*



### SPRING REVERB

● Bass control and quasi-parametric midrange control, permitting stepless adjustment of a  $\pm 12$  dB equalization range, are offered in Model 111B spring reverb. The unit has continuously variable control over center-frequency and bandwidth. A "floating threshold" limiter minimizes spring twang and provides protection from overload. The reverb has line-level balanced outputs and smooth four-spring per channel sound. The module measures 19 x 3 1/2 in.

*Mfr: Orban/Parasound*

*Price: \$695.00.*

*Circle 84 on Reader Service Card*



### MINCOM REPLACEMENT HEAD

● Manufactured in hot-pressed ferrite with glass-bonded gaps, a new replacement head for Mincom recorders may be had in all track formats. The head is plug-to-plug compatible with the original metal head used in the recorder. The manufacturer claims a life expectancy for the new head of ten times that achieved by the old metal head.

*Mfr: Saki Magnetics*

*Circle 85 on Reader Service Card*

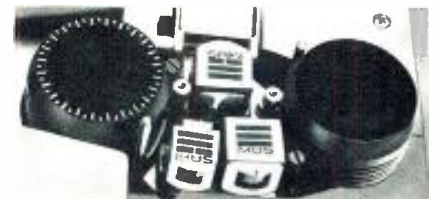

### CASSETTE DUPLICATOR

● High speed Model Super C-32 two-channel, three-slave duplicator is claimed to have the capacity to produce three C-60 cassette copies every minute. Functioning from synchronous motors, the unit operates at sixteen times the customary speed.

*Mfr: Pentagon Industries*

*Price: \$1,295.*

*Circle 86 on Reader Service Card*



## 16-24-TRACK RECORDER



● A control module which provides all the channel and tape transport functions, including the automatic rewind, and which may be remotied through a cable is featured on APD 1600 16- or 24-track recorder. The unit has phase locked dual capstans, closed loop tape drive system and reel servo systems. Variable speed control, in addition to the usual 15 and 30 in./sec. speeds, electronic braking, and easy access for servicing are also included. An accompanying module provides transport motion controls when the remote control is used at the console.

*Mfr: Bouse Mfr. Co.*

*Price: 16-track: \$18,750;*

*24-track: \$28,750.*

*Circle 87 on Reader Service Card*

## ADD-ON MIXER



● Up to six additional low impedance, balanced microphone inputs switchable to line level may be added to a sound system through Model M677 "slave" mixer, designed to be used in conjunction with other products from the same manufacturer. When used with Models M67 and M68, the unit permits the stacking of mixers as well as adding two additional mic or line level inputs over those available when stacking two four-channel mixers. Used with an SE30 gated compressor/mixer, the unit can convert the three-input system of the compressor to a nine-input mixer. When combined with M63 Audio Master, a six-channel microphone mixer results, with flexible equalization, 600-ohm line output, vu meter, and headphone monitor. In combination with the M610, M677 provides 6 inputs plus an octave graphic equalizer.

*Mfr: Shure Bros.*

*Price: \$181.20.*

*Circle 88 on Reader Service Card*

## PORTABLE AUDIO ANALYZER

● Small IE-10 octave band equalizer includes a battery operated hand-held real time audio analyzer and comes with a companion pink noise generator, IE-20. The equalizer features ten second order Chebyshev filters on ISO octave frequency centers, covering a range from 22 Hz to 22 kHz. The led display gives a point by point graphic readout; a separate USASI standard "C" curve filter provides a flashing, broadband reference point of true dB-SPL on the right side of the led display. A selectable 10 dB per step, 80 dB input range gives a zero reference line of 60 to 140 dB-SPL. The display range is also selectable in 1, 2, or 3 dB steps, yielding a dynamic display range of 16, 32, or 48 dB. Model IE-10 has a built-in condenser microphone plus an external input for an external microphone. IE-20 pink noise generator is also battery powered.

*Mfr: Ivie Electronics*

*Price: IE-10: \$487;*

*IE-20: \$147.*

*Circle 89 on Reader Service Card*

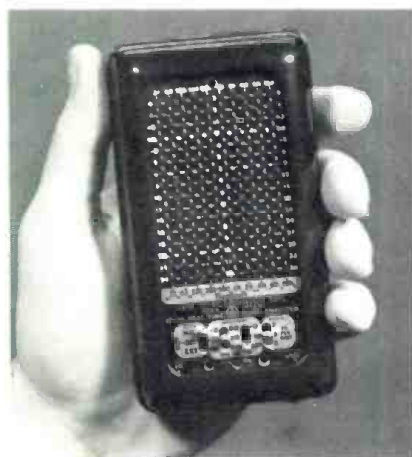

## A Natural for Remote Broadcast Production Package Disco



MONO \$1275 STEREO \$1725 SHELF \$75

Pre-wired - can be assembled in 30 minutes! In Stock

**ALLIED BROADCAST EQUIPMENT**

**124 South 6th Street**

**Richmond, Indiana 47374**

**317-962-8596**

*Circle 44 on Reader Service Card*

# New Stereo Delta-T

Give it your  
thin vocals  
your bland  
instrumentals  
your dry  
mono tracks



Now relax, playfully invite your muse, and transform these tracks, adding body, stereo perspective, flanging, and a host of other time-base effects. Since Lexicon introduced digital delay over six years ago, most studios have come to depend on it at least for doubling and slap. Now, the stereo 102-S with the new VCO module\* produces many other effects, including more natural double tracking, flanging, vibrato, time delay panning, extreme pitch modulation, and signal transformation for special effects. Of course, you can also use the two channels for completely independent processing.

The Lexicon Delta-T has earned an enviable reputation for its 90 dB dynamic range, impeccable audio quality, high reliability, and functional modularity. All this is retained in the new 102-S, while two channel operation, finer delay steps (3 ms), and the VCO have been added. And the 102-S is economical. Its totally modular construction allows you to start with a bare bones mono system and expand later as needs and budget grow. We'll help you define the configuration you need to get started. Call or write Lexicon for further information.

Write on your letterhead for AN-3, *Studio Applications of Time Delay*. A 30-minute demo tape is also available for \$1 in cassette, or \$5 on 7 1/2 ips/2 track tape.

\*The new VCO module also fits any 102-B or C mainframe to enhance its time-base signal processing capability.

## Lexicon

60 Turner Street  
Waltham, Massachusetts 02154  
(617) 891-6790

Circle 45 on Reader Service Card

products & services (cont.)

### HEADPHONE MONITORED DECK



- Stereo and mono headphone monitoring with an independent gain control are provided with a signal electronics unit giving line-in/line-out operation for Studio 8 transportable or console machines. Four further controls permit adjustment of input and output levels on each channel separately.

Mfr: Ferrograph Co. Ltd.

(Elpa Marketing)

Circle xx on Reader Service Card.

### EXPANDABLE INPUT AMPLIFIERS



- Two new models, MS-252, a 25-watt unit and MS-752, 75-watt amplifier offer expandable input options. The basic line amplifiers, identical in function and size, have built-in tone compensation and program input volume controls. Electronic mute control of the microphone channel is included, with the capability of accepting up to two additional plug-in modules for greater input flexibility. A varied selection, according to need, of plug-in accessories is optionally available. Price varies according to the complexity of additions ordered. Frequency response is  $\pm 1.0$  dB, 40-15,000 Hz.

Mfr: McMartin Industries

Circle xx on Reader Service Card.

Copies of all issues of **db—The Sound Engineering Magazine** starting with the November 1967 issue are now available on 35 mm. microfilm. For further information or to place your order please write directly to: **University Microfilm, Inc.**  
300 North Zeeb Road  
Ann Arbor, Michigan 48106



ARTHUR R. JOHNSON  
ROBERT M. HESS

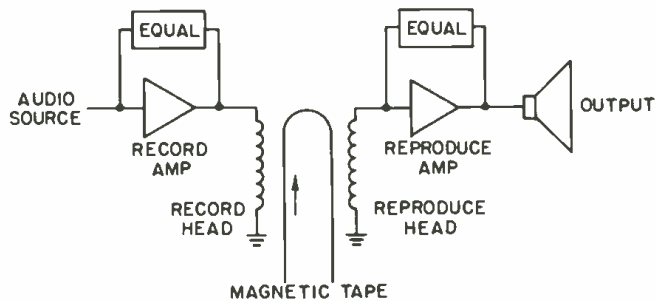

# The Why and How Of Equalization

*Faithful reproduction of sound requires adjustment of power versus frequency response through voltage of flux regulation.*

IT HAS BECOME apparent over the years that there is a need for a straightforward, but simple, explanation as to why equalization is needed, how it performs its function, and what curves (1,  $\phi$ , e) vs. frequency can be expected at various locations in a system. Too often, people in the audio business, including on occasion, some engineers, use the term *N.A.B. equalized*, and do not fully understand the significance or the usefulness of the term. This article is an attempt to simplify that explanation.

In the recording and reproduction of audio (music, voice), equalization is used in both the recording and reproducing processes. Recording and reproduce equalization, in simple terms, is the process of modifying the frequency response of the recorder and reproducer to obtain the best signal-to-noise ratio while maintaining a flat voltage *versus* frequency response. The mathematics involved can become quite complicated when head loss, tape losses, tape-to-head contact losses, and a variety of other losses are taken into consideration. It is not in keeping with the purpose of this article to pursue all of these; it is our intent to present an overall picture of how equalization affects what must be put on the tape, and how it is retrieved.

## N.A.B. EQUALIZATION

The large majority of tape reproducers, with exception of some European units, utilize N.A.B. (National Association of Broadcasters) equalization. This implies that magnetic tape recordings made are to be compatible with

these units. For the purpose of keeping this article relatively compact, equalization referred to here will be for 15 in./sec. recording and reproducing. This is the most commonly used tape speed in studio work. However, the general information is applicable to any format.

In actual fact, there could be a different set of equalization parameters for every tape on the market. This obviously is very impractical, so the N.A.B. has devised an optimum set of equalization standards. Basically, equalization standards are written around the reproducing process, because the customer's reproducer is where the tapes are to be played. Manufacturers of these reproducer units conform to these specifications.

## REPRODUCE EQUALIZATION

Reproduce equalization may be specified in either one of two methods; one being the voltage vs. frequency response of the reproduce amplifier and the other being the flux vs. frequency response of the reproduce system. In reality, both methods are correct; either can be used to define the same system.

FIGURE 1 displays graphically what these specifications look like for 15 in./sec. recordings. Curve (A) in FIGURE 1 shows the output voltage of the reproduce amplifier with respect to a constant flux level input to the reproduce head. This curve can be plotted for any reproduce system by utilizing a flux loop input or a reference tape with all tones recorded at a constant flux level. It can be calculated for correct values from the following formula:

$$\text{NdB} = 20 \log_{10} WT_1 \sqrt{\frac{1 + (WT_2)^2}{1 + (WT_1)^2}}$$

where NdB is the relative output level in dB,  $W = 2\pi f$ ,  $f$  being the frequency at which the calculation is being made.  $T_1$  and  $T_2$  are the time constants of the N.A.B. equaliza-

tion. For a tape speed of 15 in./sec.,  $T_1 = 3180 \mu\text{sec.}$  and  $T_2 = 50 \mu\text{sec.}$  and the crossover frequencies are equal to:

$$f = \frac{1}{2\pi T_1} \qquad f = \frac{1}{2\pi T_2}$$

$$f = 50 \text{ Hz} \qquad f = 3.18 \text{ kHz}$$

Utilizing the above formula, a graph can be drawn and the actual measured values can be compared to the calculated values.

### VOLTAGE VS. FREQUENCY

The other method of showing the reproduce characteristics is to plot the voltage vs. frequency of the reproduce

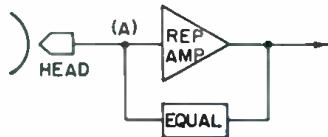
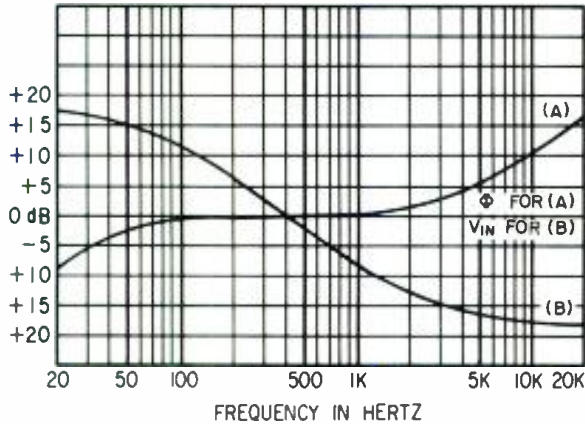
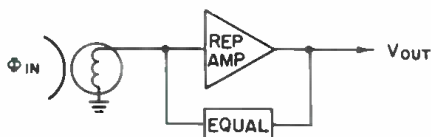
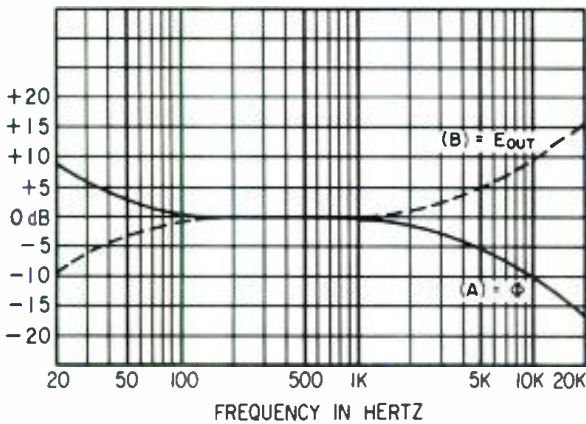

Figure 1. (A) Output voltage of an N.A.B. reproduce amplifier with constant flux input to head.  $NdB = 20 \log_{10} WT_1 \sqrt{\frac{1 + (WT_2)^2}{1 + (WT_1)^2}}$  For 15 in./sec. recording

$T_1 = 3,180 \mu\text{sec.}$   $T_2 = 50 \mu\text{sec.}$  (B) Reproduce amp output voltage vs. frequency with constant input voltage. Amp equalized for 15 in./sec. N.A.B. operation.

Figure 2. Zero dB ref. line =  $\phi$  to produce voltage (B) or voltage produced by  $\phi$  (A).



amplifier with a constant voltage input. Refer again to FIGURE 1. If a constant voltage vs. frequency were applied to point (A) of FIGURE 1, then the output voltage vs. frequency would look like curve (B). In other words, this is a plot of voltage gain of the amplifier at specific frequency points when the feedback network of the amplifier corresponds to the two time constants previously shown:  $T_1 = 3180 \mu\text{sec.}$  and  $T_2 = 50 \mu\text{sec.}$

It is obvious from curve (B) that in order to produce an output voltage that is flat with frequency variations, the input voltage must then be the inverse of this curve (B) or  $\frac{1}{N.A.B.}$  equalization curve.

A reproduce head is nothing more than a small generator and, therefore, must follow *Faraday's Law*:

$$e = N \frac{d\phi}{dt}$$

Thus, the reproduce head acts as a differentiator and the reproduced signal is actually the derivative of the recorded flux ( $\phi$  R) with the recorded flux being proportional to the record current. If  $\phi$  R (recorded flux) =  $K_1 I \sin Wt$ , then  $e$  (output volt.) =  $K_2 I \cos Wt$ .

If these formulas were pursued to their end conclusions, they would indicate:

1. The output voltage is a function of the record current.
2. The output voltage of the reproduce head is proportional to the frequency and rises at 6 dB/octave.
3. The change from sine to cosine indicates that the record current and the output voltage are 90 degrees out of phase with one another for corresponding points on the tape.
4. The output voltage will increase linearly with frequency for a constant level of recording current (with the exception of losses).

Utilizing this information, we can show graphically what the flux pattern vs. frequency on the tape must be made to look like in the record process.

### REQUIRED OUTPUT VOLTAGE

Referring to FIGURE 2, the zero dB line in one case is the relative flux level to produce the voltage vs. frequency curve (B). This should be recognized as the N.A.B. flux frequency response graph for a reproduce amplifier. This is not the output voltage we require. The required output voltage is again the zero reference line or flat voltage vs. frequency.

Figure 3. (A)  $\phi$  vs. frequency recorded on tape. (B) Output of ideal head with constant  $\phi$  vs. frequency input. (C) Constant flux  $\phi$  to produce curve (B). (D) Output of head produced by  $\phi$  (A).

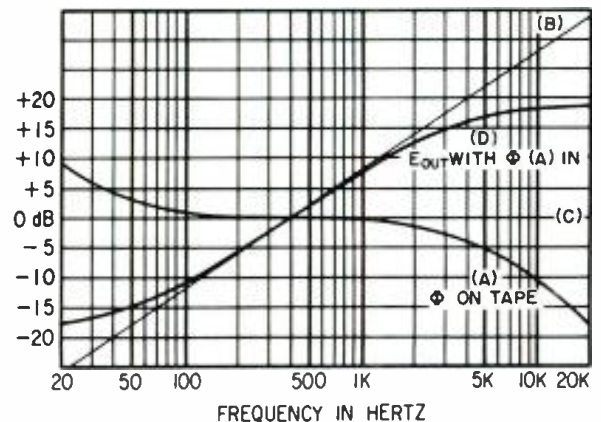

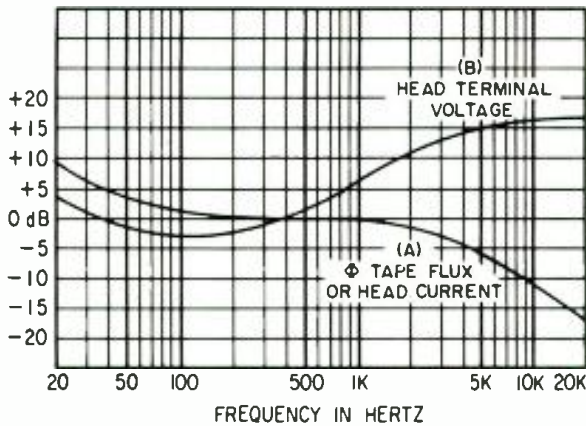

Figure 4. (A)  $\phi$  tape flux or head current. (B) Head terminal voltage.

Let us look at 20 Hz. The output voltage with a constant flux input is 8.61 dB lower than required. This can be corrected by lifting the flux level by 8.61 dB. At 100 Hz the output voltage is 0.966 dB too low with a constant flux input. Again, if we lift the flux level 0.966 dB, we have a flat output. On the other end of the graph, the output voltage is 16.07 dB too high. A decrease in the flux level of 16.07 dB would again return us to the reference line. This can be done at all frequencies and would show us the flux pattern required to produce a flat output voltage vs. frequency, or the curve (A).

At this point, it should be easy to show graphically that the output of the reproduce head is indeed the inverse of the reproduce amplifier equalization when the input flux is that shown in curve (A) of FIGURE 2.

In FIGURE 3, let the zero dB reference line again be a constant flux vs. frequency. If, as we have assumed, we have an ideal reproducing head, then curve (B) would be the output voltage of that head, rising at 6 dB per octave. This flux level-to-head-output voltage will, in our ideal head, hold true at various flux levels.

#### FLUX LEVELS

Curve (A) represents the actual recorded flux levels on the tape being reproduced. If we look at the difference between the actual flux level (A) and the constant flux level (C) and knowing that these differences will hold true for the voltage curves as well, we can plot curve (D). For example: at 20 Hz, the actual flux is 8.61 dB higher than our constant flux level. Therefore, the output of the head at 20 Hz would be 8.61 dB higher than that produced by the constant flux output. Again, at 20 kHz, the actual flux level is 16.07 dB lower and the output voltage of the head is 16.07 dB lower than that produced by our constant flux level. In this manner, curve (D) may be generated; it is, in fact, inverse of the N.A.B. equalization for reproducing, as previously stated. What remains is the process of recording these flux levels on the tape. If one analyzes curves (A) and (D) of FIGURE 3, it becomes apparent that the very familiar formula  $e = N \frac{d\phi}{dt}$  is graphically represented. Curve (D) is indeed the differential of curve (A).

A recording head, in so far as the signal source is concerned, is basically an iron core inductor with a gap in the core. Voltage applied to the windings creates a current in the windings and a flux is created in the core, proportional to the current. The tape bridging the core gap completes the flux path of the core. The flux pattern left on the tape, or *remanent flux*  $\phi_R$ , is proportional to the signal current in the head. Each magnetic particle retains

# Are you sure what the crossover point for your next installation should be?

## If not... you might think about including a Crown VFX-2 in your tool kit.



This unique, dual-channel unit has continuously variable filters. With it you can "fine-tune" the crossover point in any sound reinforcement system.

As a temporary test rig, the VFX-2 installs quickly. You can diagnose crossover problems in existing systems, no matter how old or new, and prescribe a solution.

For permanent installation, you'll find that the VFX-2 costs less than many fixed filters, and provides other advantages. For one, a 15dB gain that eliminates the need for input transformers. An 18dB per octave rolloff that's sharp by any standard. Crossover points can easily be changed to suit different performances. The VFX-2 also works as a bandpass filter, or for tri-amping a mono system.

Hum and noise 113dB below rated output (IHF), IM distortion less than 0.01%, 19 inch rack mount.

Try a VFX-2 on your next installation. Be sure.

When listening becomes an art,



**CROWN**  
Box 1000, Elkhart IN 46514

Circle 39 on Reader Service Card

the last state of magnetization to which it was subjected as it left the gap. The actual recording of flux on the tape occurs at the trailing edge of the gap.

Since the head current is proportional to the remanent flux, a graph of head current vs. frequency would look exactly like the previous graphs of recorded flux vs. frequency, not taking into account the losses of the recording system.

The record current then can be defined as  $I_{rms} = \frac{E_{rms}}{\sqrt{X_L^2 + R^2}}$

since we already know what a graph of the head current looks like. What we must plot is a graph of the voltage required at the head terminals to produce this current. The formula becomes  $E_{rms} = I_{rms} \times \sqrt{(W_L)^2 + R^2}$ , and can be used to define the voltage required at any given frequency.

Referring to FIGURE 4, curve (A) is a curve of recorded flux or head current. If some current value, say, 1 milliamp, is assigned to the zero cosine, then a current can be calculated for any point on the curve. (In this case, we are interested in the head current.)

$$dB = 20 \log_{10} \frac{I'}{I_{Ref.}}$$

$$dB = \log_{10} \frac{I'}{I_{Ref.}} = \text{antilog}_{10} \frac{dB}{20} =$$

$$\frac{I'}{I_{Ref.}} = (I_{Ref.}) (\text{antilog}_{10} \frac{dB}{20}) = I'$$

where  $I_{Ref.} = 1 \text{ mA}$  and  $dB = \text{value read from graph.}$

#### HEAD VOLTAGE

In order to construct the graphs of FIGURE 4, head characteristics must be known. The head used in this

example was a 1-inch, 8/T head from an Ampex MR-70 recorder. When checked on a Hewlett Packard universal bridge, it displayed a d.c. resistance of  $8.2\Omega$ , and an inductance of 5.04 M Henries. The impedance of the head can be calculated at any frequency from this data using the formula:

$$Z = \sqrt{(WL)^2 + R^2}$$

For example look at 400 Hz.

$$Z = \sqrt{(WL)^2 + R^2} =$$

$$\sqrt{[(2) (\pi) (400) (5.04 \times 10^{-3})]^2 + (8.2)^2}$$

$$= \sqrt{(12.67)^2 + (8.2)^2} = \sqrt{160.45 + 67.24} =$$

$$\sqrt{227.690} = 15.089\Omega$$

Using this data, head voltage at any frequency can be found using the formula:  $E_{rms} = (I_{rms}) (Z)$ . If, as earlier stated, we desire to have 1 milliamp of record current at 400 Hz, we can find the required voltage.

$$E_{rms} = (I_{rms}) (Z) = (1 \times 10^{-3}) (15.089)$$

$$= 15.089 \times 10^{-3} \text{ volts rms}$$

Using this approach, a graph of head terminal voltage vs. frequency can be constructed. The level at 400 Hz can be used as a reference (0dB). For the MR-70 head used as an example, it is the curve (B) of FIGURE 4. It can be seen that for any given set of head characteristics, the driving voltage will differ.

We would like to make it clear once again, at this point, that head loss, spacing losses, etc., have not been accounted for. They would differ for variation in tape, heads, duplicating speeds, and other system parameters. It is hoped, however, that we have presented enough information to help the reader understand basically what the overall process is and how it works. ■

## PARAMETRIC PRICE-PERFORMANCE *breakthrough*

**\$599**

SUGGESTED LIST PRICE

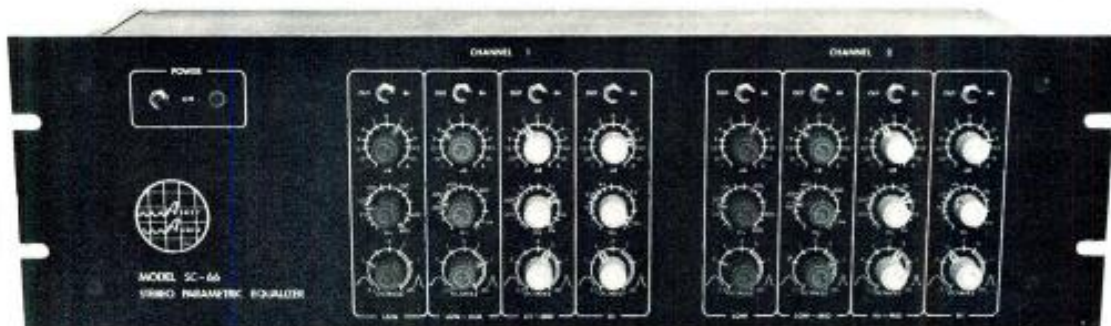

- true narrow-band (.05 oct.) through broad-band (3.3 oct.) equalization
- 50:1 frequency range, each band
- $\pm 15 \text{ dB}$  eq. range, precise center "flat" position
- separate IN-OUT switch for each band
- ultra clean & quiet ( $-87 \text{ dBV}$  noise,  $< .05\%$  THD)
- internal power supply

*At Ashly, we're definitely into Parametric Eq. We've used it extensively in our big SE series consoles for years. The SC-66 represents the culmination of these years of design, listening, and field testing. You can now have infinite control of all equalization characteristics at your fingertips with accuracy and resolution previously considered impossible. Check out an SC-66 at your pro-audio dealer.*

*Dealer inquiries invited*

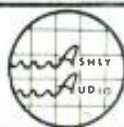

**ASHLY AUDIO INC.**

1099 JAY ST.  
ROCHESTER, N.Y. 14611  
(716) 328-9560

Circle 60 on Reader Service Card

www.americanradiohistory.com

## Complete Audio Distortion and Frequency Response ...Automatically

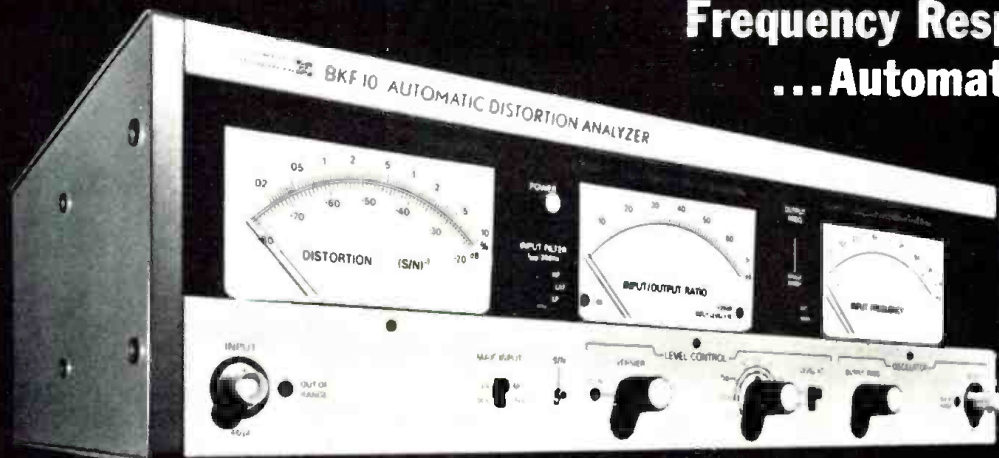

**RADIOMETER  
COPENHAGEN**

Comprehensive distortion and frequency response measurements are easily performed with the BKF10 Automatic Distortion Analyzer. This unique instrument combines a distortion meter, a low distortion audio sweep oscillator (<0.01% t.h.d.) and an input/output ratio meter. Operation is totally automatic . . . No balancing, nulling or level setting is required. Addition of a recorder provides complete distortion and frequency response curves. Send for complete information.



**THE LONDON COMPANY / 811 SHARON DRIVE / CLEVELAND, OHIO 44145 / (216) 871-8900**

*Circle 59 on Reader Service Card*

## Cētec sets the standards for Gauss. Gauss sets the standards for the Industry.



gauss

### Gauss Ultra High Speed Duplicating Systems

**Cētec Audio**

For the educated Ear

Division of Cetec Systems Ltd.  
Sapphire House  
16 Uxbridge Rd.  
Ealing, London W52BP England  
01-579-9145 Telex (851) 935847

The Gauss 1200 series from Cētec Audio is a completely flexible audio tape duplicating system that can be configured to fit almost any duplicating requirement. The Gauss 1210 Master operates at 32 times the speed of the original recording. Its modular design allows the master to be coupled with 1 to 20 Gauss 1220 slave units for an hourly production of over 4,000 copies of a 30 minute tape cartridge. Our exclusive 10MHz bias system assures less noise and distortion than any system on the market today. It's a system that guarantees maximum output per dollar invested. But more important, the duplicated product, **YOUR PRODUCT**, sets a standard for the industry. You don't have to take our word for it... your ears are our best salesmen.

A Division of Cētec Corporation 13035 Saticoy Street North Hollywood, Ca 91605 (213) 875-1900 TWX: 9104992669

*Circle 41 on Reader Service Card*

[www.americanradiohistory.com](http://www.americanradiohistory.com)

# The New Breed of VU Meters

*Fast response, easy reading, characterize the new led vu meters.*

**B**EFORE WE GET involved with the new led (light emitting diode) vu meters, let's first discuss the term *vu*. *Vu*, volume units was developed in April, 1939 by the Bell Telephone Labs and Columbia Broadcasting System (CBS) with National Broadcasting Company (NBC). The volume in *vu* is numerically equal to the number of decibels (dB) which expresses the ratio of the magnitude of the waves to the magnitude of the reference volume. Volume units, like decibels, are logarithmic and involve a power ratio. Therefore, if they are used to measure a signal (voice or music) a reference must be established. The standard reference for the volume unit is one milliwatt of power dissipated across 600 ohms of resistance. Now we can express the number of *vus* with the equation

$$N_{vu} = 10 \log \frac{P}{0.001}$$

where P represents the rms power of the signal to be measured. If P is equal to one milliwatt (1mW), the ratio in the equation is unity—therefore, making  $N_{vu}$  equal to zero. Because of this, circuits operating with 1mW are said to be at zero reference, or zero *vu*. So when P exceeds 1mW, values of  $N_{vu}$  are positive; for values of P less than 1mW,  $N_{vu}$  becomes negative.

Since 1mW of power across 600 ohms corresponds to 0.775 volts across the same value of resistance, the equation can be modified to

$$N_{vu} = 20 \log \frac{E}{0.775} + 10 \log \frac{600}{R}$$

in which E is the rms signal voltage and R the resistance across which the signal voltage is measured. The values 0.775 volts and 600 ohms are, respectively, the voltage and resistance references for *vu* measurements.

The *vu* meter must conform to all specifications on ANSI Standard C16.5-1954 entitled "American Recommended Practice for Volume Measurements of Electrical

Speech and Program Waves." All *vu* meters employ either TYPE A scale for recording applications, or TYPE B scale, which emphasizes percent modulation for broadcast use (FIGURE 1). The meter reading is zero *vu*, or 100 per cent, with application of 1.228 volts across a 3,600 ohm resistor in series with the *vu* meter. This reading represents 4 dB above one milliwatt into 600 ohms. In accordance with Standard C16.5-1954, all *vu* meters must have response time to a step change of 0.3 second,  $\pm 10$  per cent. Overshoot is 1 per cent to 1.5 per cent. Calibration follows circuit conditions as defined in the Standard.

When a *vu* meter is used on a conventional 600 ohm line, a constant impedance attenuator is used to match the meter's impedance (in series with 3,600 ohms) with the 600 ohm line. The resistor is usually built into attenuators intended for *vu* meter use. FIGURE 2 shows the standard *vu* meter as used with 600 ohm lines.

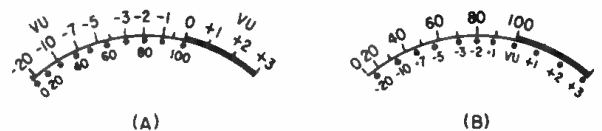
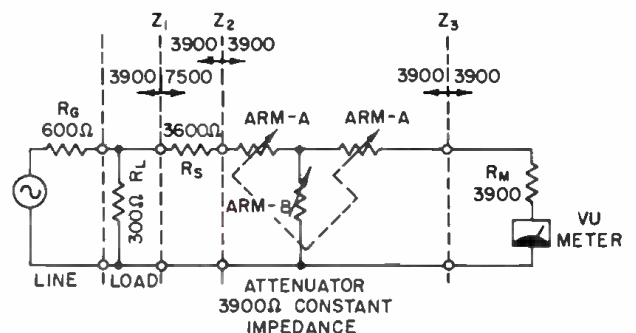

Figure 1. *Vu* meter scales. (a) Type A scale. (b) Type B scale.

Figure 2. Circuit of *vu* meter for operation on 600-ohm lines.



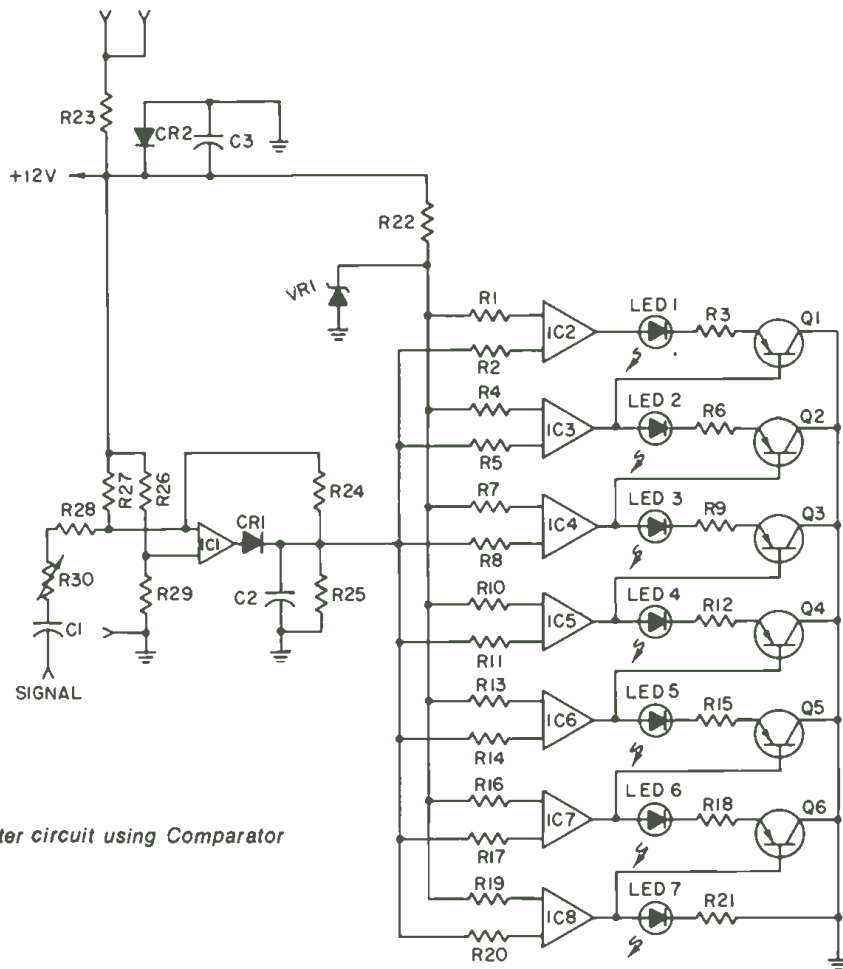

Figure 3. Led vu meter circuit using Comparator Principle.

## LED VU METER

With the ever growing field of solid state technology, we have a vu meter which has no moving parts. The meter uses leds to represent the vu meter scale. There are some advantages over the conventional vu meter in that it can respond much faster to the short term signal peaks. Also there is the elimination of inertial response limitations and wearpoints. The result is a meter capable of being read at greater distance without excessive size.

The led vu meter works on the *Comparator Principle* which is basically simple. In the led vu meter circuit diagram (FIGURE 3) one comparator (IC1) is connected as a conventional peak detector, charging C2. The amount of charge time is limited by the output impedance of IC1 and the size of C2. Discharge time is controlled by R25 and the parallel combination of R2, R5, R8, R11, R14, R17 and R20, thus determining basic time constants for the meter. R23 and C3 form a decoupling circuit for any switching transients produced in the circuit. R22 and VR1 form a regulated voltage standard for the device. R3, R6, R9, R12, R15, R18 and R21 limit current through the light emitting diodes (leds). Led 1 through led 7, which are (in a volume unit (vu) meter) labeled -15 through +3 vu as shown in FIGURE 4.

Application of the led vu meter is as follows: R1, R4, R7, R10, R13, R16, R19 set an equal current level into each current-sensitive comparator, IC2 through IC8, determined by the voltage of VR1 and the size of the resistors. This assures that each comparator will trip at the same operating point for maximum accuracy. When the signal applied reaches sufficient amplitude to force current through R2 in excess of that through R1, IC2 output will go positive and conduct current through led 1, R3 and

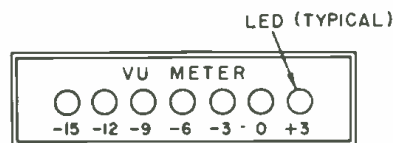

Figure 4. Led vu meter face.

transistor Q1 which is held on by the low output of IC3. Led 1 then lights and indicates a -15 vu signal level. As the signal increases still further, IC3 output goes positive, turns off Q1 and led 1 and turns on led 2, indicating the next higher signal level. The remaining stages operate in the same manner with increasing signal level. The last stage (IC8) remains on with large signal levels, thus indicating an overload.

In the led vu meter just discussed, we have seven leds. However, there are others with more leds for a wider scale, using the *Comparator Principle*.

The led vu meter has a couple of disadvantages. It doesn't indicate the loudness of the program and can't read the rms of the signal. The conventional vu meter is still necessary, enhanced by the led vu meter. ■

### References:

- Bernstein, Julian L. *Audio Systems*. John Wiley & Sons, Inc., 1966.
- Weston Instruments, Application Data A-4800-1, May, 1950. Pulse Dynamics Mfg. Corp., Technical Data on M-241 led meter.
- API Instruments, Bulletin 0514-PB4, February, 1975.

# The UREI Model 200 Automatic Response Plotting System

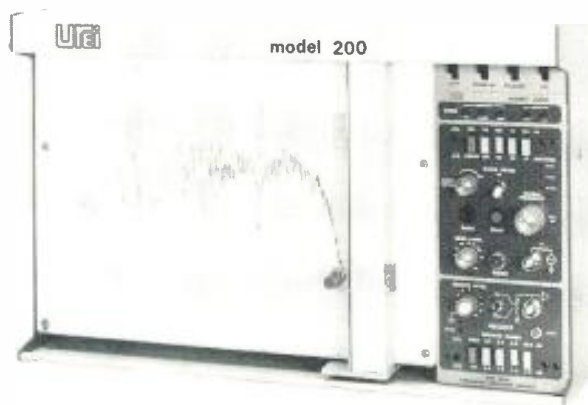

*The UREI Model 200 Automatic Response Plotting System.*

**U**P TO NOW, a practical system for quick hard copy frequency response testing has been something either not available or priced out of the reach of most. There have been cathode-ray tube-faced analyzers for some time now, and they could be interfaced with an x-y plotter for a permanent copy—or a Polaroid camera could be used on the c.r.t.

In either case, a lot of money and bench space is required if this method is elected.

## ENTER UREI

The UREI Model 200 combines in a single compact package a Hewlett-Packard servo-driven x-y plotter and an automatic sweep generator with following receiver that covers the 20-20,000 Hz audio band. UREI has designed the plug-in module that fits the x-y frame. This module contains all the audio generator and drive electronics. The module itself is designated as Model 2000 and it is expected that the future will see other modules from UREI.

## WHAT THIS SYSTEM DOES

This first module makes the Model 200 system into an

automatic sweep frequency generator and receiver with variable sweep speeds.

In an x-y plotter used for audio measurements, the horizontal (x) movement is frequency, while the vertical movement (y) is gain. The Model 200's electronics drive the servo motors that control both motions. A pen attached to a carriage can thus trace onto paper a direct record of both the x and y movements it is directed to make.

The ingenuity of this system is that it uses a standard paper that is readily available in art supply stores—K & E regular three cycle semi-log paper. But you are not even limited to this paper. The electronics are calibrated for both inches and centimeters, so you can also use DIN standard paper as well.

The paper fits onto the platen of the plotter easily, and is readily adjusted and aligned into place (more on this presently). Once into place, a switch activates an electrostatic hold down system that locks the paper from movement, yet permits ready removal when the tests are finished.

## THE PLUG-IN MODULE

As mentioned, the plug-in module contains all the





Figure 1. The face of the Model 2000 plug in module. The apparent knob directly below the word send at the center of the unit is actually a knurled screw that secures the module into the frame.

electronics for the system. As shown in FIGURE 1, the face is divided into three sections. At the top, five leds indicate what the switches in the lower two sections have selected.

The larger section is the send section or generator. The five push buttons toward the top serve a dual purpose. With the left-most button raised, the remaining buttons select the sweep speed of the generator and plotter. You can select total sweep times of 15, 30, 60, and 120 seconds.

What this means is that a component under test that is connected to both send and receive sections will have the total 20-20,000 Hz test done in the time selected.

Why are there four speeds? The faster the sweep, the more the pen will tend to gloss over subtle changes in level. For some systems under test, this is not a problem. A power amplifier, for example, does not normally show steep sudden changes in response, so the fast sweeps could be used.

They can be used even under sharp transient slope testing because a special *slope sense* switch located just below the sweep selector switches lets you have your cake and eat it too. This switch activates an automatic rate sensing circuit and control, which ensures accurate tracing of steep amplitude excursions without the need for the slow sweep speeds. The circuit automatically slows the sweep rate when rapid amplitude changes are encountered and resumes normal sweep rate following the excursion.

### SEND SECTION

Let's get back to those five pushbuttons at the top of the send section. When the left-most button is depressed, this becomes a calibrating system. The remaining buttons will then select a specific frequency and move the plotter to that position. The switches will select 20, 100, 1k, or 10 kHz. Thus the exact alignment of the pen and paper can be checked with precision.

Other controls on the send section include a sweep vernier, which when depressed activates an ability to extend the switch selected sweep time by up to ten times. You sometimes want very slow speeds, as when checking

Figure 2. The frequency response accuracy of the unit. The paper must be carefully aligned for perfection, but with the electrostatic holddown system, this is easily accomplished

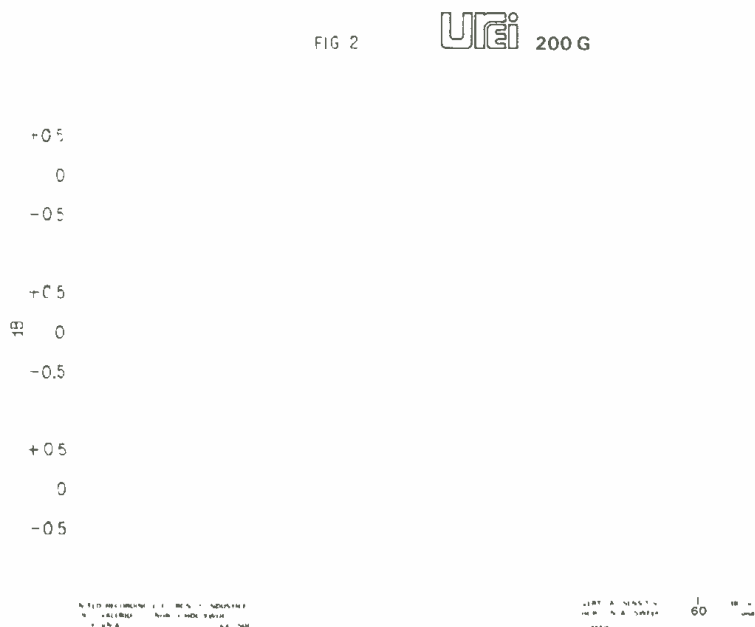

FIG 2

URi 200 G



Figure 3. A tracing of 18 dB notch filters as provided by the UREI Feedback Suppressor. The curves have been drawn with the slope sense of the Model 200 on (A) and off (B). Sweep time was 30 seconds.

a tape recorder. If you are feeding the generator into the deck and pulling the resultant output from the tape off the playback system, there will be a time error due to the effect of the record and play heads. Since the plotter system is time controlled rather than frequency controlled, the resultant pen tracing would be transposed slightly horizontally.

In practice, however, the use of a 60 second sweep even at a tape speed of 7½ in./sec. will produce a negligible offset.

The variable sweep speed is useful if other than the internal 20-20,000 sweep is used. It makes possible a synchronizing of the plotter to the test tape or disc.

There are more controls on the send section. At the lower center right, when activated by pulling it up, a manual frequency control will serve to drive the entire system manually over the full frequency range. This permits a "dry run" to be easily accomplished. Of course, you will only know what frequency you are at while turning this knob by looking at the previously calibrated positioned paper and the position of the pen above it.

The final send control at the lower left is the output gain adjustable from -50 dBm to +14 dBm. Output is via a BNC-type connector.

### THE RECEIVE SECTION

The receiver portion contains an input gain control and a switch to select loading of the unit under test by either 50k or 600 ohms. Input is via another BNC-type connector. Another set of five pushbuttons selects the vertical range of the plotter. With the left-most button down, the system is calibrated in inches; up it is calibrated in cm.

You will select according to the paper you are using; our tests were with the K & E inch calibrated paper. So a choice exists among having one inch of paper (and the pen's vertical motion) equal 1, 2, 5, or 10 dB. You can well imagine that if one inch equals 10 dB, a tremendous amount of subtle detail can be examined. Also, broad signal-to-noise measurements can be made at this setting.

With the left-most switch raised, the other selectors choose 0.5, 1, 2, and 4 dB per centimeter.

A small button toward the right center of this receive section raises the input gain by 10 dB while depressed. It's a momentary hold button and can be used for checking vertical calibration at any time.

### LAB TESTS

A wide variety of components were put under test by this instrument to see its versatility. Some of the graphs it can draw are illustrated. But first, FIGURE 2 was drawn by taking the send signal and feeding it directly to the input receiver. UREI specs the system as ±0.5 dB over the entire 20-20,000 Hz range. Our graph shows it as well within those parameters. The graph has been drawn at three different levels to show that the unit is not level sensitive in its frequency response flatness.

Calibration stability is stated to be ±0.25 per cent/24 hours. We haven't the facility to measure stability much more than that, so can only state that our sample is also well within those parameters.

Total harmonic distortion of the sine wave signal from the generator is less than 1 per cent at any frequency or level up to +10 dBm. At mid band frequencies it is well under 0.35 per cent.

The ability of the unit to follow complex wave forms with and without using the slope sense control is demonstrated in FIGURE 3. As can be seen, this unit is well designed for complex curve tracings of graphic equalizers etc.

The unit comes with H-P supplied blue and red pens which fit into a holder on the travelling arm of the plotter. In addition, a second holder is supplied, which permits the use of several standard felt tip pens, so a high degree of versatility is permitted, both as to line thickness and color. The pen lifts from the paper automatically at either end of the frequency spectrum. It can also be lifted manually via a switch.

Finally, our examination of the mechanical and electrical construction leads us to believe that this will prove a durable and reliable unit. It is well packaged, and with an accessory carrying case, becomes readily portable.

The UREI Model 200 has a list price of \$2,250.00. As such it represents a very real value indeed considering the space and time saving facility it offers. L.Z. ■

Closing date is the fifteenth of the second month preceding the date of issue.

Send copies to: Classified Ad Dept.

db THE SOUND ENGINEERING MAGAZINE

1120 Old Country Road, Plainview, New York 11803

Rates are 50¢ a word for commercial advertisements.

Employment offered or wanted ads are accepted at 25¢ per word.

Frequency discounts: 3 times, 10%; 6 times, 20%; 12 times, 33%.

## FOR SALE

CLASSES IN 16/24 track music recording techniques, disc mastering, record production. Taught by famous engineers and producers at modern recording studios. **Saga of Sound, 9200 Sunset #808, Hollywood, CA 90069, (213) 550-0570.**

MODERN RECORDING TECHNIQUES by Robert E. Runstein. The only book covering all aspects of multi-track pop music recording from microphones through disc cutting. For engineers, producers, and musicians. \$9.95 prepaid. **Robert E. Runstein, 44 Dinsmore Ave. Apt. 610, Framingham, Mass. 01701.**

FREE CATALOG of studio kits, consoles, p.a., discrete opamps. **QCA, Box 1127, Burbank, Ca. 91507.**

WIRELESS MICROPHONES. Professional hand held and lavalier wireless microphones, new and used. **EDCOR, 3030 Red Hill Ave., Costa Mesa, Ca. 92626. (714) 556-2740.**

DYNACO RACK MOUNTS for all Dynaco preamps, tuners, integrated amps. \$24.95 postpaid in U.S., \$22.50 in lots of three. **Audio by Zimet, 1038 Northern Blvd., Roslyn, N.Y. 11576. (516) 621-0138.**

COOPER TIME CUBE. Used for demo use only. Like new. \$850. **Fisher-Burke, P.O. 2468, Phoenix, AZ 85003. (602) 257-0225.**

ARP SYNTHESIZERS: Strings, \$1,385; 2600, \$2,190; Axex, \$700; Prosoloist, \$875, Odyssey, \$1,165. **Dickstein Distributing, 1120 Quincy, Scranton, Pa. 18510.**

CUSTOM CROSSOVER NETWORKS to your specifications; a few or production quantities. Power capacities to thousands of watts; inductors and capacitors available separately; specify your needs for rapid quotation. Also, PIEZO ELECTRIC TWEETERS—send for data sheet and price schedules. **TSR ENGINEERING, 5146 W. Imperial, Los Angeles, Ca. 90045. (213) 776-6057.**

MICROMIXERS—16 inputs, E.Q., monitor mix, mic pad, mute, etc. P.A. and stereo versions. Write for literature. **Gately Electronics, 57 W. Hillcrest, Havertown, Pa. 19083. (215) 449-6400.**

DUPLICATOR REPAIR CENTER for all brands of in-cassette duplicators. Factory-trained technicians. Work warranted. Also big selection of new and used duplicators. **Tape and Production Equipment Company, 2065 Peachtree Industrial Court, Atlanta, Ga. 30341.**

PROFESSIONAL MONITOR TUNING. Even the finest control room designs require speaker line tuning for accurate response. **Milam Audio** uses only the finest Real Time equipment to read and correctly perform monitor tuning. For information, contact: **Milam Audio Co., 1504 N. 8th St., Pekin, Ill. 61554. (309) 346-3161.**

AUDIOARTS ENGINEERING, 286 Downs Rd., Bethany, Conn. 06525. Tolex-covered portable 19 in. rack equipment cases.

WHATEVER YOUR EQUIPMENT NEEDS—new or used—check us first. We specialize in broadcast equipment. Send \$1.00 for our complete listings. **Broadcast Equipment & Supply Co., Box 3141, Bristol, Tenn. 37620.**

NEW YORK'S LEADING DEALER specializing in semi-pro and professional recording and p.a. equipment. Teac, Tascam, Sound Workshop, Nakamichi, dbx, MXR, Dynaco, Ads, Frazier, Eventide, Electro-Voice, Shure, Scotch, Maxwell, Otari, Ampex, and more. We go both ways: lowest prices in sealed factory cartons, or complete laboratory check-out and installation. All equipment on display. **AUDIO BY ZIMET, 1038 Northern Blvd., Roslyn, L.I., New York 11576. (516) 621-0138.**

MCI . . . the finest name in Audio Recorders and Consoles, now offers one-to 24-track master recorders and up to 40-in/40-out automated consoles. For midwest factory representation, contact: **Milam Audio Co., 1504 N. 8th St., Pekin, Ill. 61554. (309) 346-3161.**

REELS AND BOXES 5" and 7" large and small hubs; heavy duty white boxes. **W-M Sales, 1118 Dula Circle, Duncanville, Texas 75116. (214) 296-2773.**

AST: THE PROFESSIONAL SOUND STORE. Full line of ALTEC and CROWN professional audio, commercial, and musical sound equipment; GAUSS and CERWIN-VEGA speakers; factory authorized service on most speakers. Large stock of ALTEC replacement diaphragms available. **AST, 281 Church St., New York, N.Y. 10013. (212) 226-7781.**

4 TRACK AMPEX TAPE Recorder- Ampex AG-440B. Fairchild 741 lathe with Fairchild 686 head and equalizer, Neumann M52H head and equalizer, Conax, 200 watt Bogen amplifier. Will sacrifice—excellent condition. Call or write: **Marjon Records—159 Easton Road, Sharon, PA 16146 (412) 347-4726.**

AUDIOARTS ENGINEERING Model 3100A parametric equalizer/preamplifier. **Audioarts Engineering, 286 Downs Rd., Bethany, Conn. 06525.**

### BODE FREQUENCY SHIFTERS SINCE 1963

Professional quality frequency shifters for electronic music studios (Models 735 & 750). Anti-feedback model 741 for p.a. systems. Also featuring polyfusion synthesizer modules and systems. For details contact:

**Harald Bode  
BODE SOUND COMPANY  
1344 Abington Pl.,  
N. Tonawanda, N.Y. 14120  
(716) 692-1670**

## RADFORD

Order Radford direct from England! Immediate dispatch by air of HD250 stereo amplifier, ZD22 zero distortion preamp, Low Distortion Oscillator ser. 3, Distortion Measuring Set ser. 3, speakers and crossovers. Send for free catalogues, speaker construction plans, etc.

### WILMSLOW AUDIO

Dept. Export DB, Swan Works, Bank Square, Wilmslow, Cheshire, England

## FOR SALE

AMPEX SCULLY TASCAM, all major professional audio lines. Top dollar trade-ins. 15 minutes George Washington Bridge. **Professional Audio Video Corporation, 342 Main St., Paterson, N.J. 07505. (201) 523-3333.**

PRE-OWNED EQUIPMENT for sale: one MCI JH16 recorder w/autolocator & 8 track heads \$13,500. One MCI JH416 console, \$13,500. Both for \$25,000. One Scully 280-2 w/ new heads & remote control \$2,500. One Ampex AG440B-4, \$4,000. One Ampex AG440C-4, \$5,800. One Revox A-77 HS 1/2 track in rack mount \$750. Two dbx-157, \$450 each. **Abadon/Sun, Inc., P.O. Box 6520, San Antonio, TX 78209, (512) 824-8781.**

TEST RECORD for equalizing stereo systems. Helps you sell equalizers and installation services. Pink noise in 1/3 octave bands. type QR-2011-1 @ \$20. Used with precision sound level meter or B & K 2219S. **B&K Instruments, Inc., 5111 W. 164th St., Cleveland, Ohio 44142.**

AMPEX TAPE. Ampex Audio studio mastering tapes; 631-641, 406-407, and "Grand Master" in stock for immediate shipment; 1/4", 1" and 2"; factory fresh. Best prices. **Techniarts, 8555 Fenton St., Silver Spring, Md. 20910. (301) 585-1118.**

CROWN DC-300A's at 20% off. Tascam Model 5's and 80-8's, reduced to sell. Similar saving on Sentry IIIs and IVAs, dbx 216, 187, 177, 152, and other noise reduction units. E-V & Shure mics, AKG BX10s; All NEW-factory guaranteed. Call today, ask for Ben at **Rowton Professional Audio, 4815 Clarks River Rd., Rt. 4 Box 5, Paducah, Ky. 42001. (502) 898-6203.**

OTARI MX5050 QXH, 4ch/4tr. rec/rep. **(402) 432-2193.**

FOR SALE: 16-track erase head. Only used 10 hours. Wired to plug into Ampex MM1000. Will fit any Ampex MM1000, MM1100, or MM1200. Purchased new from Ampex. \$800. Contact: **Howard Steele, (213) 466-4306.**

**ONE STOP  
FOR ALL YOUR PROFESSIONAL  
AUDIO REQUIREMENTS  
BOTTOM LINE ORIENTED  
F. T. C. BREWER CO.  
P.O. Box 8057, Pensacola, Fla. 32505**

## NAGY SHEAR-TYPE TAPE SPLICERS



FDR CASSETTE 1/4" & 1/2" IN. TAPES  
• HAND-CRAFTED  
• FIELD PROVEN  
• FAST, ACCURATE  
• SELF-SHARPENING

**NRPD Box 289 McLean, Va. 22101**

TWO ALTEC 986.0A ACTIVE equalizers, one Spectra Model #610 comp/limiter, two Klein & Hummel Gotham EQ1000 equalizers, one EMT model 516 PDM compressor, one B&K model 123 spectrum shaper 12.5 to 40k #2. **Rodel Audio Services, 1028-33 Street, N.W., Washington, DC 20007, (202) 338-0770.**

DECOURSEY ACTIVE ELECTRONIC CROSSOVERS. Model 110 dividing network; complete with regulated power supply, for bi-amp, tri-amp, or quad-amp. Custom assembled to meet your specifications. Monaural, stereo, or with derived third channel. Plug-in Butterworth (maximally flat) filters; 6, 12 or 18 dB per octave at any desired frequency. OPTIONS: Summer for single woofer systems. VLF hi-pass filters for elimination of subsonic noise, derived third channel. FOR OEM OR HOME ASSEMBLERS: Model 500 or 600 dual filters. Regulated power supplies. Write for new brochure. **DeCoursey Engineering Laboratory, 11828 Jefferson Blvd., Culver City, Ca. 90230. (213) 397-9668.**

THE LIBRARY . . . Sound effects recorded in STEREO using Dolby throughout. Over 350 effects on ten discs, \$100.00. Write, **The Library, P.O. Box 18145, Denver, Colorado 80218.**

STUDIO SOUND—Europe's leading professional magazine. Back issues available from June '73 through June '75. \$1 each, postpaid. **3P Recording, P.O. Box 99569, San Francisco, Ca. 94109.**

PRODUCERS-ENGINEERS—8-track studio time available, mid-Manhattan. Fully equipped. **(212) 852-3295.**

VARI-SPEED for Ampex MM-1100, AG 440-C; d.c. servo motors only. \$229 each. Manufacturer, **MCH Electronics, 6801 Jericho Tpke., Syosset, N.Y. 11791. (516) 364-8666.**

\$2 MILLION USED RECORDING EQUIPMENT. Send \$1.00 for list, refundable, to **The Equipment Locator, P.O. Box 99569, San Francisco, Ca. 94109. 94109.**

FOR SALE: USED SHURE Audio console SR101 with carrying case model A101A and panel lamp model A101B. Operation and service manual included. \$750. **Jim Pearce, 18 East 39th, Kansas City, MO 64111 (816) 531-2920.**



When precision quality is important!  
**AEG-TELEFUNKEN  
TUBES**

**HARRISON ELECTRONICS**  
20 Smith St. Farmingdale, N.Y. 11735  
(Dealers invited)

OBERHEIM 4-VOICE polyphonic synthesizer with built-in mini-sequencer. List \$4400, sell \$3800. **Gregg Karukas, (301) 262-5208.**

CROWN INTERNATIONAL. Complete repair, overhaul, and rebuilding service for current and early model Crown tape recorders and amplifiers. New and used machines bought and sold. **TECHNIARTS, 8555 Fenton St., Silver Spring, Md. 20910. (301) 585-1118.**

TRACKS!! The complete semi-pro recording center. Get our low prices on Tascam, TEAC, Neotek, Multi-Track, dbx, MXR Pro, Shure, BGW, Tapco and many others. Complete studio packages available. Tracks!! from **DJ's Music Ltd., 1401 Blanchan, La Grange Park, IL 60525. (312) 354-5666.**

AUDIOARTS ENGINEERING Model 5200A professional disco mixer/preamplifier. **Audioarts Engineering, 286 Downs Rd., Bethany, Conn. 06525.**

COMMUNITY LIGHT & SOUND professional sound products. **Brandy Brook Audio, P.O. Box 165, Seymour, Connecticut 06483. (203) 888-7702.**

ORBAN-PARASOUND 621A parametric equalizer, new. Cost \$439. Must sell. \$300/ best offer. **Jim, 26 Lomavista, Larkspur, CA 94939 (415) 924-5976.**

HARMONIC PERCUSSION for older Hammond organs. Easy installation, \$75. Free details. **Linear Devices, P.O. Box 5750, San Francisco, CA 94101.**

FOR SALE: Spectra Sonics/Auditronics console; 16-in/6-out 8-track monitoring. Call **George Clinton, AC (318) 861-0569.**

**FREE CATALOG & AUDIO APPLICATIONS**

CONSOLES  
KITS & WIRED  
AMPLIFIERS  
MIC. EQ. ACM.  
LINE TAPE DISC.  
POWER  
OSCILLATORS  
AUDIO  
TAPE BIAS  
POWER SUPPLIES

**OPAMP LABS, INC.**  
1033 N. SYCAMORE AVE.  
LOS ANGELES CALIF 90038  
924 5884

### PRO AUDIO EQUIPMENT & SERVICES

Custom touring sound, 2-, 4-, and 8-track studios, disco systems. Representing Akai, AKG, Allen & Heath, Altec, Beyer, BGW, Cetec, Cerwin-Vega, Community Light & Sound, dbx, Dynaco, Dokorder, Emilar, E-V, Furman, Gauss, Kelsey, Lamb, Langevin, 3M, Martex PM, Maxell, Meteor, Russound, Revox, Sennheiser, Shure, Sony, Soundcraftsman, Sound Workshop, Spectra Sonics, Switchcraft, TDK, TAPCO, TEAC, Technics, Thorens, and more. Offering these professional services: custom cabinet design, room equalization, loudspeaker testing, custom crossover design, electronics modification, and custom road cases. Call or write for quotes, or drop us a line for our latest catalogue. **K&L Sound, 75 N. Beacon St., Watertown, Mass. 02172. (617) 787-4073. (Att.: Ken Berger.)**

PROFESSIONAL COMMUNICATION contractor in Philadelphia, Pa. area requires a competent, technically qualified salesperson. Please send resume and requirements to: **General Sound, Inc., 3500 N. 9th St., Philadelphia, Pa. 19140.**

DUPLICATORS, blank cassettes, recorders, boxes, labels, cassette albums and supplies; lowest prices, top quality. Write for free brochure, "50 Tips for Better Duplication." **Stanford International, Box 546, San Carlos, Ca. 94070.**

AMPEX SPARE PARTS; technical support; updating kits, for discontinued professional audio models; available from **VIF International, Box 1555, Mountain View, Ca. 94042. (408) 739-9740.**

INFONICS DUPLICATORS! For a bunch of reasons, you can't afford not to consider Infonics Duplicators — especially since factory installation and training are included in the list price. **INFONICS DUPLICATORS, (219) 879-3381.**

NEUMANN CONSOLE: 24 inputs; 8 mixing busses, with 31 track monitor mix-down interface. Solo position on all inputs, tracks, and busses; patchfield in console and 20 x 16 patchfield in 6 ft. rack plus many more extras. Call **Don Frey, A & R Recording, Inc., NYC (212) 582-1070.**

LUXURIOUS NYC BROWNSTONE with state-of-the-art 4-track studio in basement. Ideal for jingles, film, record production. Very favorable terms. Call collect **(212) 255-4043** for details.

PROKITS—SM-6A and SPM-6. Your best mixer value. Write for literature. **Gately Electronics, 57 W. Hillcrest, Havertown, Pa. 19083. (215) 449-6400.**

DUAL LIMITER/PREAMP described in Aug. '76 issue *db Magazine*; P.C. boards, \$18; kits, \$175; wired and tested, \$275. Info write: **Robert R. Faulkner, Box 26, Redondo Beach, Ca. 90277.**

A FEW competitively priced used Revox A77 and A700 decks available. Completely reconditioned by Revox, virtually indistinguishable from new and have the standard Revox 90-day warranty for rebuilt machines. Satisfaction guaranteed. Write requirements to **ESSI, Box 854, Hicksville, N.Y. 11802. (516) 921-2620.**

AMPEX SERVICE COMPANY: Complete factory service for Ampex equipment; professional audio; one-inch helical scan video; video closed circuit cameras; video systems; instrumentation and consumer audio. Service available at **2201 Lunt Avenue, Elk Grove Village, IL 60007; 500 Rodier Drive, Glendale, CA 91201; 75 Commerce Way, Hackensack, NJ 07601.**

ELECTRO-VOICE SENTRY PRODUCTS. In stock: Sentry IV-B, Sentry III, and Sentry V monitor loudspeaker systems for professional monitoring and sound reinforcement. Immediate air freight shipment to any N. American destination. Florida dealer inquiries invited. **National Sound Co., Ft. Lauderdale, Florida. (305) 462-6862.**

AMPEX 350 & 351 recorders. Altec console; Moviola editor; motion picture & audio gear; priced to sell. **NorthWestern, Inc., 011 S.W. Hooker, Portland, OR 97201.**

3M 4-TRACK/IN CONSOLE 15-30 i.p.s.. excellent. \$3,900; Sony C-57 condenser microphone, \$125; Countryman 967 phase shifter. \$190; V.S.O. McIntosh 200 watt, \$400; 4 Studer A-80 Mark I electronics (100 hrs. use). \$800; AKG-Bx 20E reverb w/remote. \$2,500 or best offer; J.B.L. 4350 speakers. \$1,050 each, still in warranty. **(213) 461-3717, ask for Brian.**

### WANTED

WANTED: Telefunken 251, Neumann U-48, U-49, or AKG C12 Mics, call **(213) 461-3717 ask for Brian.**

### EMPLOYMENT

ENGINEER/TECHNICIAN with experience and ambition to join forces with the guys at ECR. Beautiful, State of the Art 8tk studio, 45' semi-trailer mobile, MCI transports, Dolby A, rapidly expanding. Must be creative, and have a good eye for the future. Ground floor! Send resume to: **Eagle Creek Recording Co., Ltd., P.O. Box 435, Rosetown, Saskatchewan, Canada, SOL 2V0, (306) 882-2742.**

FIELD ENGINEER with 1st class F.C.C. to work for progressive young company. Must have RF experience and be willing to travel. Contact: **Fisher-Burke Broadcasting Consultants, P. O. Box 2468, Phoenix, AZ. 85003.**

IMPORTANT NEW RESEARCH AND PERFORMANCE facility in Paris, France, now under construction, which will explore physical acoustics, psychoacoustics, electronics, computers, linguistics, etc., as related to music theory and practice, is seeking permanent recording engineer who is aesthetically flexible, knows how to utilize 24-track equipment, a technician, scientific thinker with strong interest in avant-garde music. Position available immediately. Send complete resume, salary requirements to **Music Masters, Inc., 1730 E. 24th Street, Cleveland, OH 44114.**

CHIEF ENGINEER for NYC recording studios. Must have heavy experience in all facets of electronics and automation for audio, film, video; leadership qualities. **Dept. 73, db Magazine, 1120 Old Country Rd., Plainview, NY 11803.**

AUDIO/ELECTRONIC ENGINEER needed for custom design, construction, repair and maintenance of professional audio equipment. Four studios include 16-track, location and film. Permanent position. **RECORDIST/MIXER** needed for music recording. Experience in commercial jingle work preferable. Permanent position. **Dept. 101, 1120 Old Country Road, Plainview, NY 11803.**

24-TRACK STUDIO in San Juan, Puerto Rico seeks experienced recording-mixing engineer. Excellent opportunities. Send resume or call **Ochoa Recording Studios, Inc., GPO Box 3002, San Juan, Puerto Rico 00936. (809) 764-4440.**

PROFESSIONAL SOUND equipment salesman. Send resume and requirements, **Mr. Moore, P.O. Box 264, Myerstown, PA. 17067.**

EXPERIENCED MUSIC MIXER For major N.Y.C. studio, expanding staff. Send resume to **Dept. 72, db Magazine, 1120 Old Country Rd., Plainview, NY 11803.**

● **George Boardman** has been named corporate news manager at **Ampex Corporation**, Redwood City, California. Mr. Boardman was formerly with **McKenna/Michel Public Relations** and was at one time business editor and city editor of the **San Mateo Times**.

● Four twenty-minute training cassettes have been prepared by **TEAC** to acquaint engineers and students with their Accuphase line and Model 2 mixer. Heading the training program is **Theo Mayer**, assisted by **Linda Feldman**, who have also put together a multi-media presentation using four projectors entitled "The Care and Feeding of Your Tape Recorder." Information may be had from **Bill Campeau** of TEAC at 7733 Telegraph Rd., Montebello Ca., 90640.

● The formation of a new England region has been announced by the **Warner Cable Corp.**, of New York City. **Edward J. DeMarco, Jr.** will focalize the new region, comprising cable t.v. systems from Maine to Connecticut.

● Further growth of **Road Runner Recordings** of Evergreen, Colorado has incorporated a 3M Series 56 16-track recorder, bringing big sound to the Rockies. **Todd Wheeler** and **Bill Stuber** operate the mobile studio.

● Two corporate staff promotions have been made at **UMC Electronics Co.**, North Haven, Conn. **Edward G. McHugh** has been appointed senior vice president and **Edmund L. Bellin** will serve as assistant secretary, moving up from the post of controller. Mr. McHugh has been with the firm since 1947. Mr. Bellin was previously associated with **Olin Mathieson**.

● **Roger W. Cappello** has been appointed president of **Harvel Industries Corp.** of Voorhees, N.J. The firm is the parent corporation of **Fidelipac**. Mr. Cappello has been vice president and general manager of **Fidelipac** and was connected with **Clear Shield Plastics Corp.** and **International Technova-tion**, also Harvel firms.

● Technical papers, films, and other presentations are now being solicited for **NOISEXPO '77**, the National Noise and Vibration Control Conference and Exhibition scheduled for March 14-17, 1977 at the Holiday Inn at Chicago's O'Hare Airport. Contact **NOISEXPO '77**, 27101 E. Oviatt Rd., Bay Village, Ohio 44140. The telephone number is (216) 835-0101.

● **Lester Bollinger** has been named manager, broadcast field sales, for **Fisher-Burke Broadcast Consultants** of Phoenix, Arizona.

● Several changes have been made at **Modular Audio Products** of Bohemia, N.Y. Coming from **Allison Audio Products**, **Leslie F. Cooley** has joined Modular Audio as chief engineer. Mr. Cooley has an impressive number of "top 100" records to his mixing credit. **Sylvan Ginsbury Ltd.** of Teaneck, N.J. has been appointed world-wide export sales representatives for the firm. Another new representative appointment is that of the **John E. M. Anderson Company** of Minneapolis to cover Minnesota, North and South Dakota, and the western portion of Wisconsin.

● **Clyde (Bud) Coffman** has been promoted to the position of national service manager at **Superscope, Inc.** of Chatsworth, California. Mr. Coffman has been with the firm since 1969, both in their U.S. and Canadian operations.

● **John Abdnour** has joined **International Tapetronics Corporation**, Bloomington, Ill., as a sales engineer. Mr. Abdnour was formerly with the **Systems Marketing Corporation**.

● For quad enthusiasts, there's a free booklet just prepared by CBS, called **Spatial High Fidelity Through SQ Quadraphonic Recording and Broadcasting**. It gives a picture of quadraphonic broadcasting, as well as guidance for the ultimate product, in the hi-fi listening room. Copies may be obtained from **Sherman Levin**, Director, Information Services, CBS Technology Center, 227 High Ridge Rd., Stamford, Conn. 06905.

● Another page in the stereo regulation controversy was inscribed recently by **Kahn Communications, Inc.**, of Freeport, N.Y. with the filing of a petition with the FCC to institute Rule Making Proceedings looking toward a change in regulations which would allow a.m. broadcasters to operate stereophonically on a permissive basis. The contention of the petition is that a.m. stereo systems are completely compatible with standard a.m. broadcasting and will in no way degrade present broadcast service and will allow listeners to enjoy stereo broadcasts with no further investment in new equipment.

● **Consumer Product Marketing** of Lafayette, California has been appointed representatives for the **Altec/Lansing** consumer hi fi products of the **Altec Sound Products Division**. The firm, under the aegis of **Dick Wilkins** and **Ed Mason**, will handle Altec products in northern California and Nevada.

● Long-time RCA engineer **David S. Newborg** has been appointed manager of radio station equipment products for **RCA Broadcast Systems**. Mr. Newborg, who joined the firm in 1943, will be based at the company's headquarters in Camden, N.J.

● **Richard A. Majestic**, designer of the CM912 amplifier and CC3 pre-amplifier, has started his own business, **RAM Audia Systems**, in Redding, Conn. RAM will offer a line of audio components including tuners, preamplifiers, frequency equalizers, power amplifiers and speaker systems designed by Mr. Majestic.

● Two new appointments have been made at the Video Division of **Memorex**, Santa Clara, California. **Henry G. Hensman** has been named general manager and **David P. Berry** marketing manager. Mr. Hensman moves from the Computer Tape Division. Mr. Berry was formerly a product manager in the Video Division.

● **Bruce F. Johnson** has been appointed president and chief executive of the **Starr Broadcasting Group, Inc.** of New Orleans, La. Mr. Johnson, an attorney and financial expert, was formerly with the **Sterling Recreation Organization** in Seattle. In his new post, Mr. Johnson will be based in New York City.

● **Marcia Greene** has assumed coordinating and administrative roles at **Arrest Records**, Washington, D.C., responsible for office, studio and accounting systems, personnel hiring and external contact, a rather remarkable switch for the female half of the brother/sister irrepressible all-night disc jockey talk team. "Brother Truck and Sister Lady," popular during the early 70's, **Mitch Litman**, "Brother Truck," is also at Arrest as director of creative services and artist development.

● Responsibility for sales in eleven western states for **Spectrol Electronics Corp.** of City of Industry, California has been assumed by **Johnny Johnston**. Before his recent appointment, Mr. Johnston was with **Schweber West**.

JUST PUBLISHED!

# John Woram's

NEW BOOK FOR RECORDING ENGINEERS, TECHNICIANS AND AUDIOPHILES

# The Recording Studio Handbook

Now off press and available at a special introductory price.

The technique of creative sound recording has never been more complex than it is today. The proliferation of new devices and techniques require the recording engineer to operate on a level of creativity somewhere between a technical superman and a virtuoso knob-twirler. This is a difficult and challenging road. But John Woram's new book will chart the way.

*The Recording Studio Handbook* is an indispensable guide. It is the audio industry's first complete handbook that deals with every important aspect of recording technology.

Here are the eighteen chapters:

- The Decibel
- Sound
- Microphone Design
- Microphone Technique
- Loudspeakers
- Echo and Reverberation
- Equalizers
- Compressors, Limiters and Expanders
- Flanging and Phasing
- Tape and Tape Recorder Fundamentals
- Magnetic Recording Tape
- The Tape Recorder
- Tape Recorder Alignment
- Noise and Noise Reduction Principles
- Studio Noise Reduction Systems
- The Modern Recording Studio Console
- The Recording Session
- The Mixdown Session

In addition, there is a 36-page glossary, a bibliography and five other valuable appendices.

John Woram is the former Eastern vice president of the Audio Engineering Society, and was a recording engineer at RCA and Chief Engineer at Vanguard Recording Society. He is now president of Woram Audio Associates.

This hard cover text has been selected by several universities for their audio training programs. With 496 pages and hundreds of illustrations, photographs and drawings, it is an absolutely indispensable tool for anyone interested in the current state of the recording art.

The regular price of *The Recording Studio Handbook* is \$35. For a limited time only—until November 31, 1976, we are offering this book at a special introductory price of \$27.50. To place your order, use the coupon below.

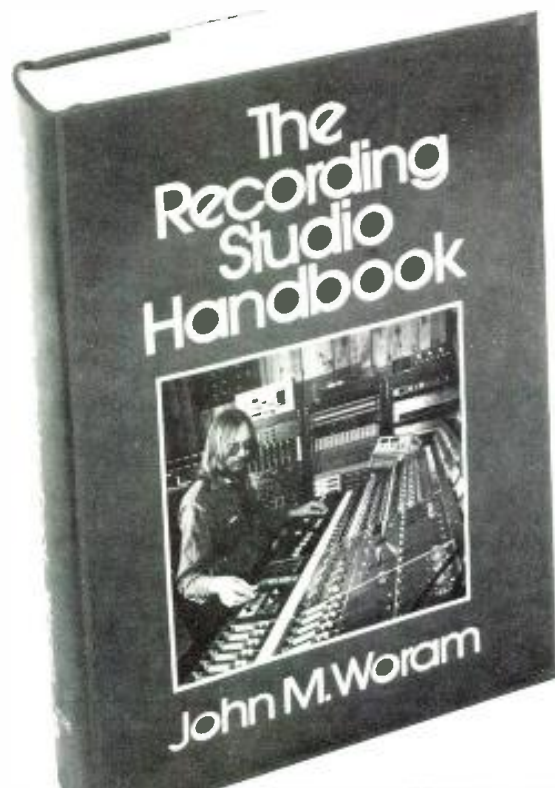

SAGAMORE PUBLISHING COMPANY, INC.  
1120 Old Country Road, Plainview, N.Y. 11803

Yes! Please send \_\_\_ copies of *The Recording Studio Handbook* at \$27.50 each.

Name \_\_\_\_\_

Address \_\_\_\_\_

City/State/Zip \_\_\_\_\_

Total Amount \_\_\_\_\_

N.Y.S. Residents add 7% sales tax \_\_\_\_\_

Enclosed is check for \$ \_\_\_\_\_  
Outside U.S.A. add \$2.00 for postage

# Think of them as your musical instruments.



The audience can't see you. But they can sure hear you.

They don't know it, but they're depending on just one person to get the music to them. And that guy is you.

It's not something an amateur can do. It's an art. And that's why Yamaha has designed 3 superb mixing consoles with the qualities and range of controls that the professional sound reinforcement artist needs.

For instance, our exclusive 4x4 matrix with level controls gives you more exacting mastery over your sound than the conventional method of driving speaker amps directly from the bus outputs.

Features like that are years away except on the most expensive mixers. On the Yamahas, it's standard equipment. And so are transformer

isolated inputs and outputs, dual echo send busses, an input level attenuator that takes +4 dB line level to -60 dB mike level in 11 steps, and 5-frequency equalization.

Whether you choose the PM-1000-16, the PM-1000-24 or the PM-1000-32, Yamaha gives you the flexibility you need to turn your job into an art. And because they're designed from the ground up to perform on the road, more and more professional sound men around the United States and the world are depending on Yamaha, night after night, gig after gig.

If you've never thought of your mixing console as a musical instrument, we'd like to invite you to stop by your Yamaha dealer. Once you've checked out the operation manual and tested for yourself what the PM Series can do, we think you'll come away a believer.



Box 6600, Buena Park, CA 90620

Circle 11 on Reader Service Card

[www.americanradiohistory.com](http://www.americanradiohistory.com)